



OPERATING INSTRUCTIONS

ProSens (Ex)

ONLINE DUST MEASUREMENT



certified
according
to **ATEX**



For the 1st use of the sensor, correct sensor type should be selected via the screen or the software. Software must be installed if needed.

1. SOFTWARE INSTALLATION

If you want to communicate with our sensor using our dedicated software, you need to download the latest version on our website and install it.

→ <https://www.envea.global/solutions/process-optimization/dahs-software/>

It might also be necessary to install drivers, also available on our website.

2. MSE 300-FH (WITH SCREEN)

The display is touch-sensitive. Available keys are displayed directly in context. When the measuring system is first started, a query is initiated to select the language and sensor.

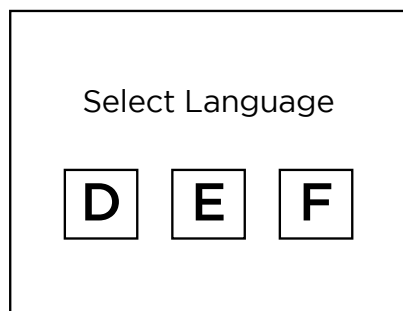

Initialization screen when the Evaluation unit in the field housing started first time.
Selection of the menu language: Deutsch, English, Français.

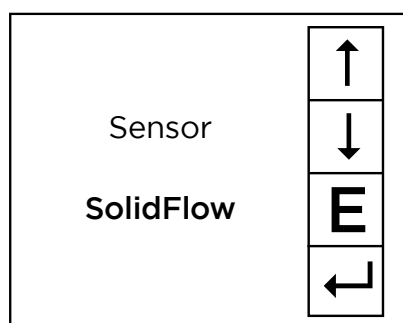

If a language has been selected, the sensor to be used must be selected. To be available:
SolidFlow 2.0, Paddy, PicoFlow, MaxxFlow HTC, DensFlow, SpeedFlow 2.0, SlideControl 2.0, ProSens, M-Sens 2, M-Sens 3, AirFlow P, M-Sens WR3.

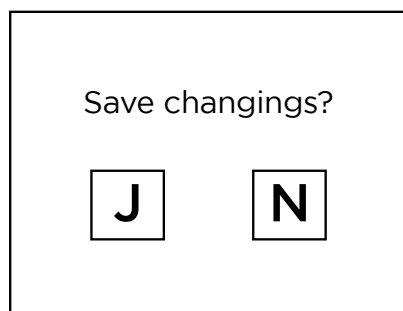

If any data has been changed, the change will only be taken into account when you exit the complete menu structure and answer [Yes] when asked if you wish to save the changes. Afterwards the start page appears.

3. MSE 300-DR / -DR2 (NO SCREEN)

Our dedicated software must be used to connect to the sensor Evaluation unit.

Select software language

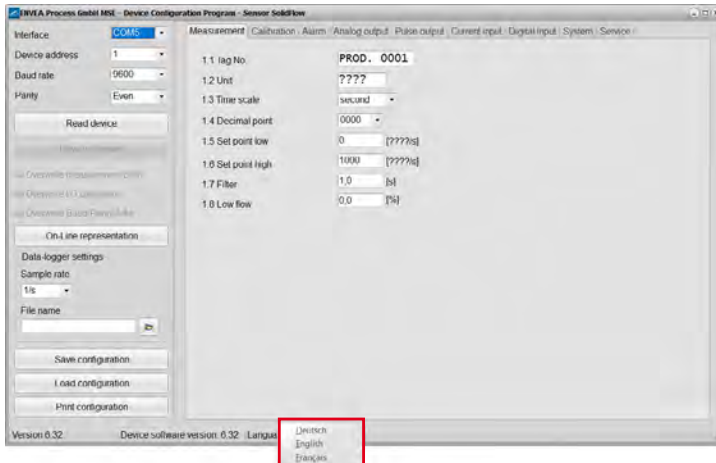

Right click on „Sprache/Language/ Langue“ and select desired language.

Connect to sensor

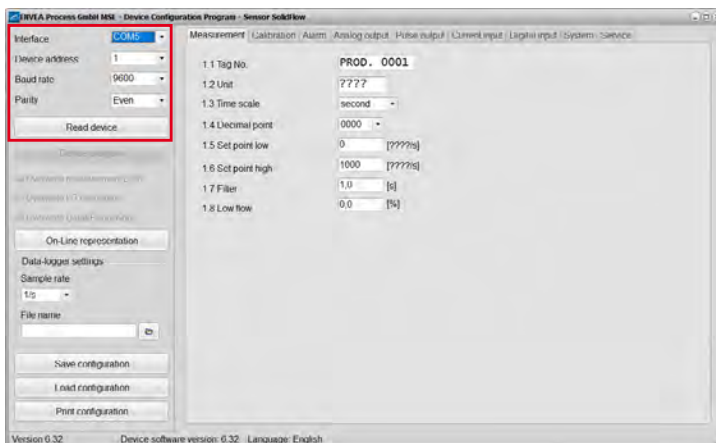

Select the correct COM port and connect to the device using the „read device“ button.

Select correct sensor

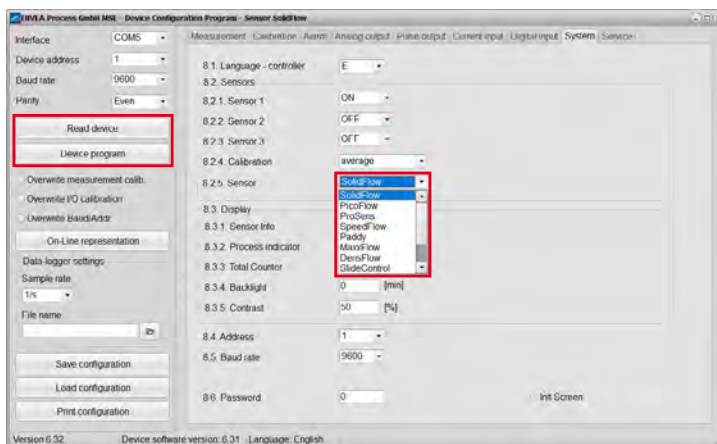

In the menu „System“, under „Sensor“ (8.2.5 or 7.2.5), the correct sensor must be selected.

After selecting the sensor, check the box „Overwrite measurement calib.“ and confirm with the button „Device program“.

For more informations and details, please refer to the user manual of the sensor.

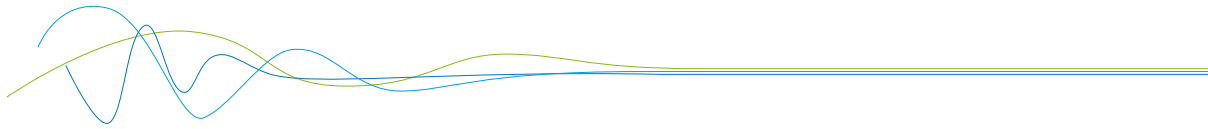

CONTENTS

	Page
1. Introduction	3
1.1 Safety	3
1.2 Product overview	3
1.3 Reliability	3
1.4 How the device works	3
2. Installation	4
2.1 Determining the installation site	4
2.2 Sensor installation - Standard	6
2.3 Sensor installation - High temperature socket	6
2.4 Sensor installation - mounting with TriClamp	7
3. Safety	8
3.1 Normal use	8
3.2 Identification of hazards	8
3.3 Occupational and operational safety	8
3.4 Maintenance	9
3.5 Technical statement	9
3.6 Reliability	9
3.7 Storage conditions	9
4. Electrical connection	10
4.1 Sensor connection	10
4.2 Evaluation unit MSE 300	11
4.3 DIN Rail Evaluation unit	12
4.4 Connecting multiple sensors using the C3-Box	13
4.5 Use in Ex hazardous areas	14
4.6 Related standards	15
4.7 Um	15
5. Dimensions	16
5.1 Sensor	16
5.2 Field housing Evaluation unit	16
5.3 DIN Rail Evaluation unit	17
5.4 C1 Box dimensions (optional)	17
5.5 C3 Box dimensions (optional)	18
6. Operation	18
6.1 Basic operation of the touchscreen (only field housing)	18
6.2 Basic information on the user interface	19
6.3 Differences between the DIN Rail and field housing Evaluation unit	19
6.4 Display	20
6.5 PC interface	22
6.6 Menu structure	25
7. Fitting up to 3 sensors	34
8. Maintenance	35
9. Warranty	35
10. Error message / Sensor status	35
10.1 Response to errors	35
11. Technical data	36

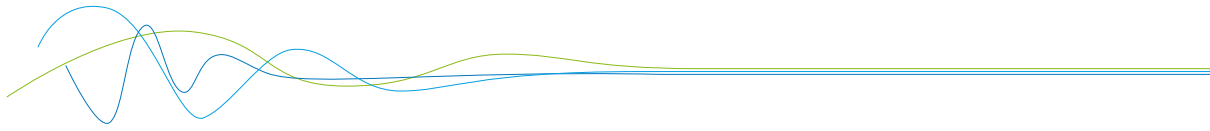

1. Introduction

1.1 Safety

The ProSens dust sensor requires a $24 \pm 10\%$ V DC supply. $24 \pm 10\%$ V DC is regarded as safe.
The DIN Rail converter requires a $24 \pm 10\%$ V DC supply. $24 \pm 10\%$ V DC is regarded as safe.

Precautionary measures:

The pipe must be opened for installation and maintenance.
The following risks must be borne in mind:

- Harmful escape by gas or dust.
- Escaping material may be inflammable, explosive or toxic.
- Escaping material may be hot or pressurised.

1.2 Product overview

The ProSens dust sensor is a microprocessor-based, preset device for measuring dust concentrations in a moving air stream. The ProSens serves for monitoring the pure side after filter elements and for the quantitative measurement of dust concentrations in exhaust air ducts.

The ProSens is a compact device for simple installation and functioning. The sensor electronics are accommodated in an IP 66 housing. The Evaluation unit is accommodated in a maintenance housing with touchscreen as standard.

A DIN Rail converter is also available, which is configured via a PC. The PC configuration can be carried out at the Field housing via USB or RS 485 interface.

USB or RS 485 communication is possible for the DIN Rail evaluation.

PC software, which can also be used to change internal parameters of the sensor (filter times, alarm retention times etc.), is optionally available. This software also allows parameter files and log files from the measuring value logging to be saved, with an additional option for trend visualisation.

The ProSens is designed for use in applications of up to 2 bar pressure and 500 °C.

The system can optionally be installed in explosive zones of category 1/2 gas + dust.

The sensor is connected to a 4-wire cable, via which the supply and digital communication is routed to the Evaluation unit.

1.3 Reliability

For any additional information concerning product reliability, please contact ENVEA Process.

1.4 How the device works

The ProSens dust measuring instrument is based on the electrodynamic technology: Dust particles streaming past or impinging on the probe exchange the smallest electrical charges with the probe.

These small electrical charges lead to a signal, which is proportional to the dust load in the air flowing past, even if particles accumulate on the probe.

A reliable measuring value can consequently be attained with this almost maintenance-free and non-wearing measuring system.

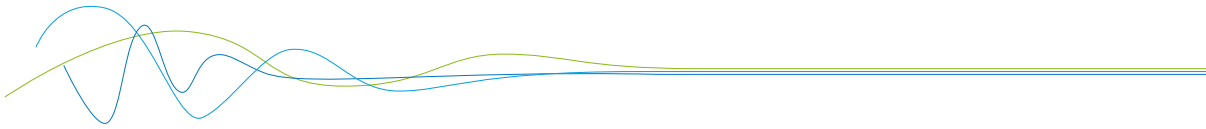

The device is ready for operation immediately after switching on with default settings and is configured and calibrated either with the Evaluation unit MSE 300 or with the configuration software. The use of a PC is required for commissioning measuring units with DIN Rail evaluation. Freely definable alarm thresholds for a minimum or maximum alarm are available within the measuring range. If the relay contact “normally closed” (NC) is used, the sensor is automatically tested for power failure. The internal error message from the sensor also signals any faults occurring via the relay. The Evaluation unit provide a 4 ... 20 mA power output as a measuring value output or or as trend display for the dust load. If a fault is found during the internal function test, the power output is set to 2 mA.

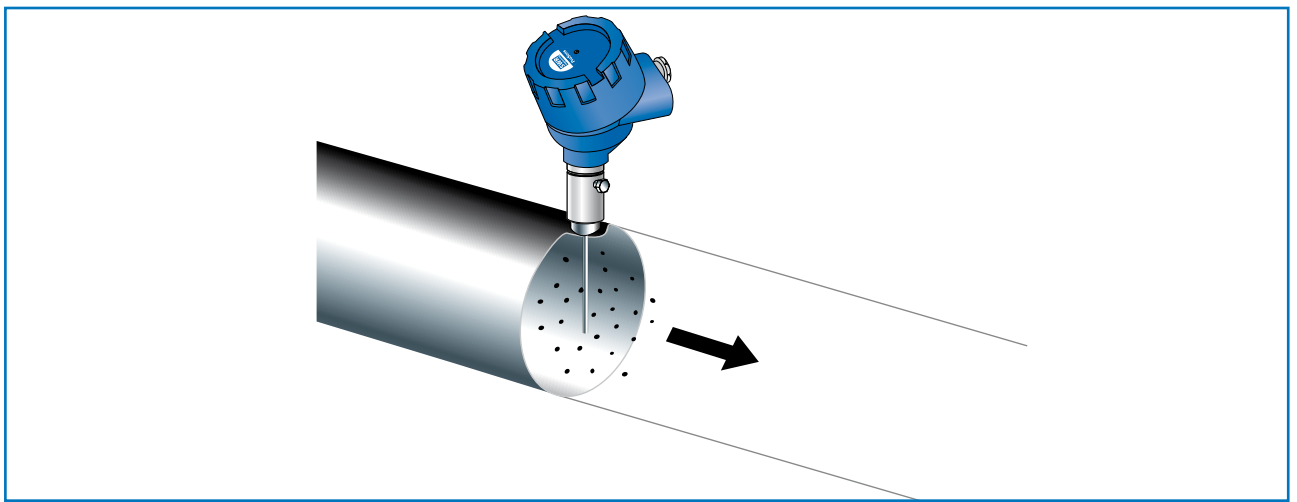

Fig. 1

2. Installation

2.1 Determining the installation site

The best installation position for the sensor in a duct or a pipe is located in an area, in which the particles undergo a uniform distribution and flow past the sensor at a uniform velocity.

The installation site can be in a horizontal or vertical pipe.

In the best case, the duct or pipe continues upstream and downstream of the installation site horizontally or vertically and fittings or manifolds, valves or slides have a minimum distance to the sensor in both directions. (See Fig. 2)

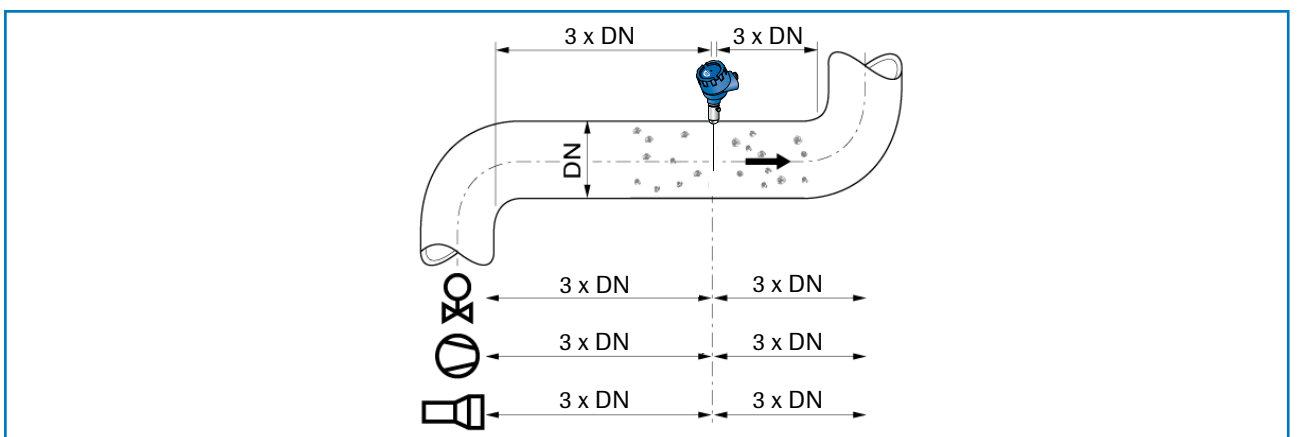
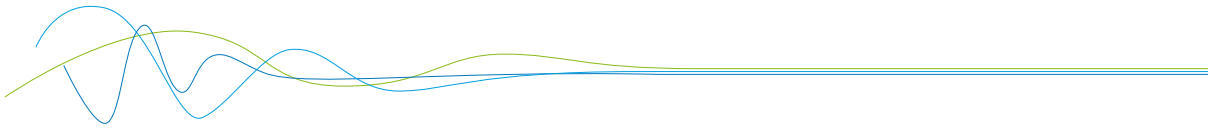

Fig. 2: Recommended distances to valve, etc. (DN = nominal diameter)



The best possible installation location should be chosen in applications that cannot fully satisfy the requirements for the installation location.

The dust sensor must be installed in a metallic duct in order to attain sufficient shielding against electrical influences.

In case of non-metallic lines, a metal casing, a metal foil or a fine-meshed metal net with a length of approx. 5 times the pipe diameter must be provided upstream and downstream of the measuring point.

It must also be ensured that the duct and sensor are earthed properly.

1. The ProSens should be installed so that the dust impinges on the sensor rod at an angle of 90°.
2. In horizontal pipes with a round cross-section, the ProSens can be installed in any position above the horizontal axis (between 9 and 3 o'clock). (See figure 3a)
3. In horizontal pipes with a square cross-section, the installation can be in the centre at the top or side. (See figure 3b)
4. Even though the sensor function is not impaired by vibration, strong vibrations should be avoided, as they can lead to destruction of the electronics.
5. The sensor should not be exposed to direct sunlight, or used in area with an ambient temperature of more than 60 °C.
6. The sensor rod must not come into contact with the opposite pipe wall or any other device! The electrodynamic signal would be short-circuited by this. The length of the sensor can be shortened to a minimum length of 70 mm for this. The plastic sleeve must not on any account be damaged here.
 - The length of the sensor rod should be minimum 1/3 and maximum 2/3 of the duct diameter. However, it must always be ensured that contact through bridge formation does not result, even if deposits form on the inside wall of the pipe.
 - A golden rule: the lower the dust concentration, the longer the rod length.
7. A position downstream of the blower is generally recommended as an installation position for monitoring a filter system. If the sensor is used downstream of an electric filter, the distance to the electric filter should be minimum 20 metres. Even though the sensor function is not impaired by vibrations, very high vibrations over a longer time period should be avoided.

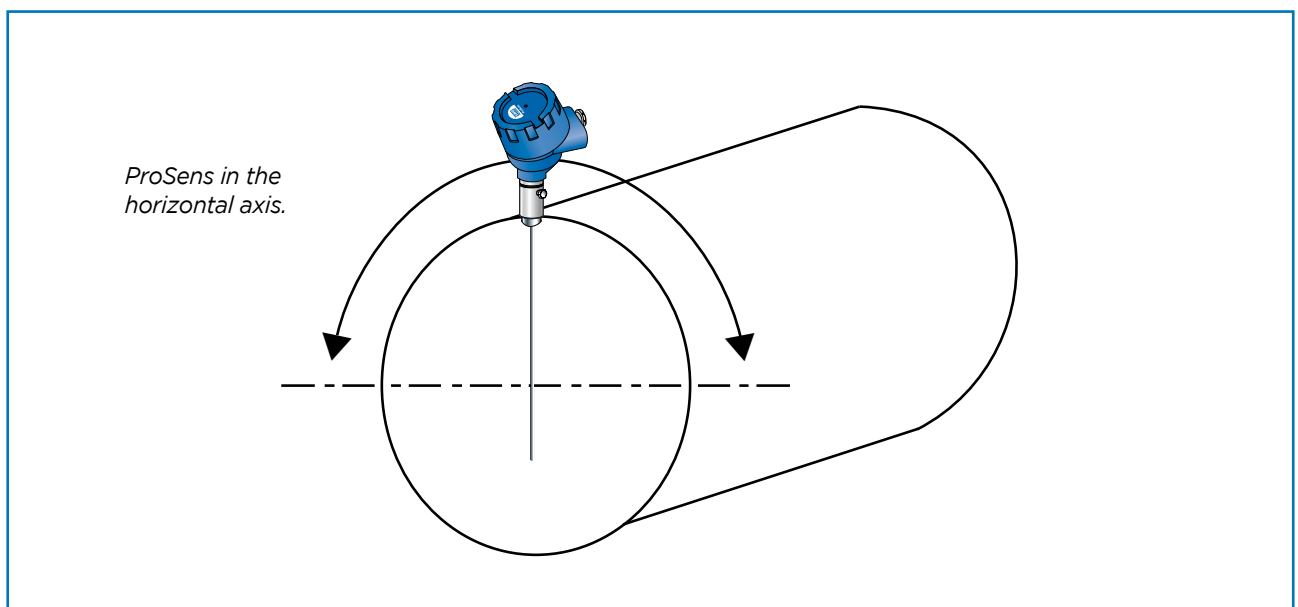

Fig. 3a: Round cross-section

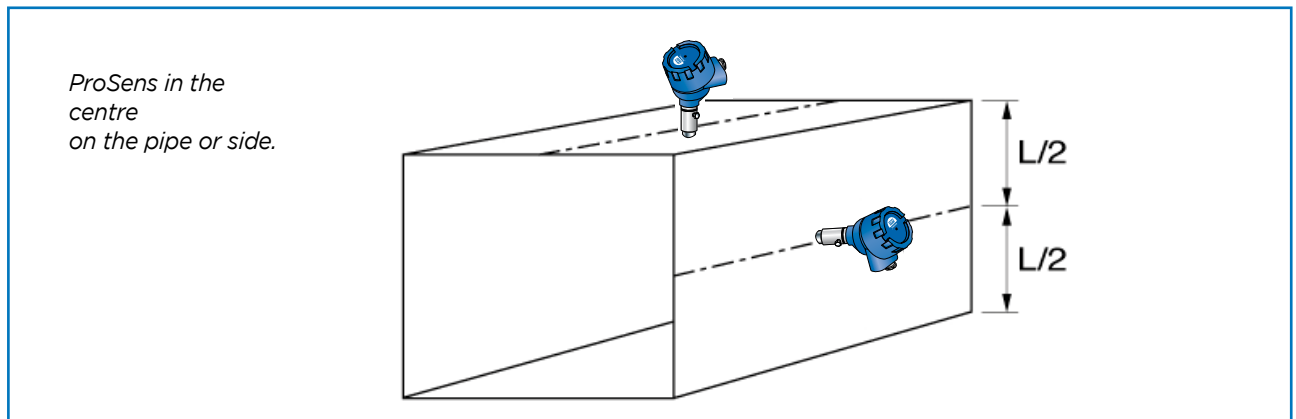

Fig. 3b: Square cross-section

2.2 Sensor installation - Standard

The R 1" internal threaded socket is first welded onto the pipe wall in the chosen installation location and fully drilled to the inside diameter of the socket. The sensor is then screwed in tightly. Check the connection for tightness.

Important:

- Use the correct tool (wrench size = S37) and place it on the G 1" screw connection. Do not screw the sensor in by hand since the screw connector could come loose and this can damage the electronics.
- Incorrect installation will void the warranty!

2.3 Sensor installation - High temperature socket

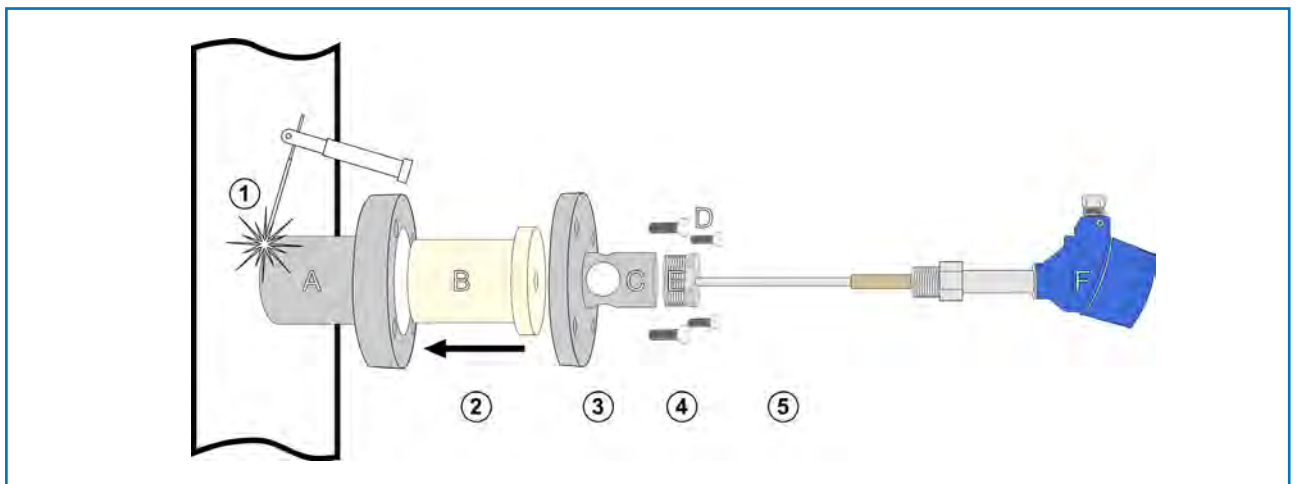

Fig. 3c: Square cross-section

- 1 Weld the main socket (A) onto the pipe in the chosen installation location and fully drilled to the inside diameter of the socket.
- 2 Carefully insert the ceramic cartridge (B) into the socket.
- 3 Position the flange (C) and mount it with the 4 bolts (D). Use the proper tool (Wrench size 27).
- 4 Install the G 1 " - 1" adapter (E). Use the proper tool.
- 5 Install the ProSens sensor into the assembled socket following instruction in 2.1.

2.4 Sensor installation - mounting with TriClamp

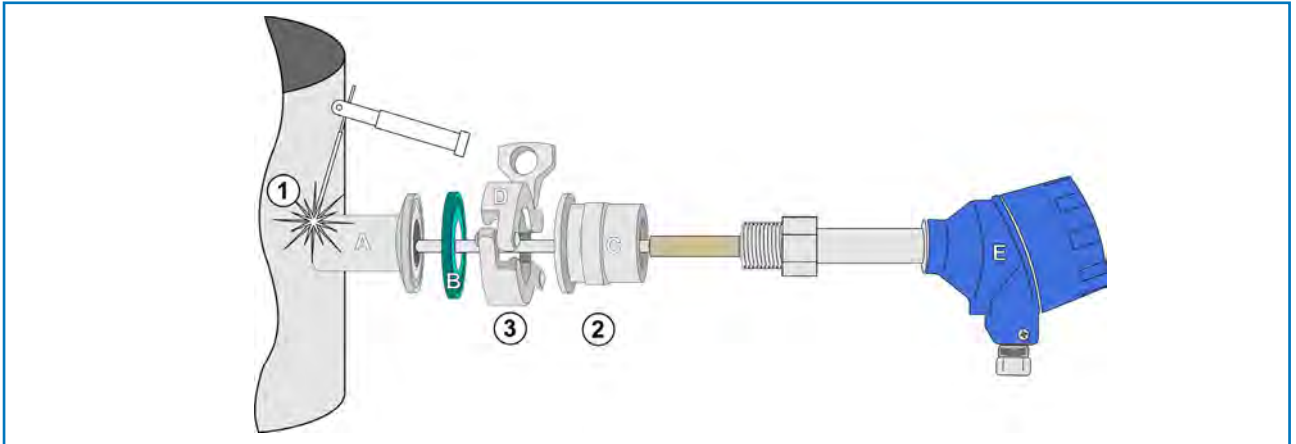

Fig. 3d: Mounting Operations

- ① Weld the flange "A" on the duct wall and opened by drill completely. (\varnothing 20 mm)
- ② Mount the sensor "E" on female socket "C" using the proper wrench.

Caution:

- Use the correct size wrench. Do not screw the sensor in by hand since the screw connector could come loose and this can damage the electronics.
- Do not undo the grub screw in the housing plinth.

- ③ Lock female socket "C" on welded socket "A" using the clamp collar "D".
Do not forgot the clamp gasket "B"

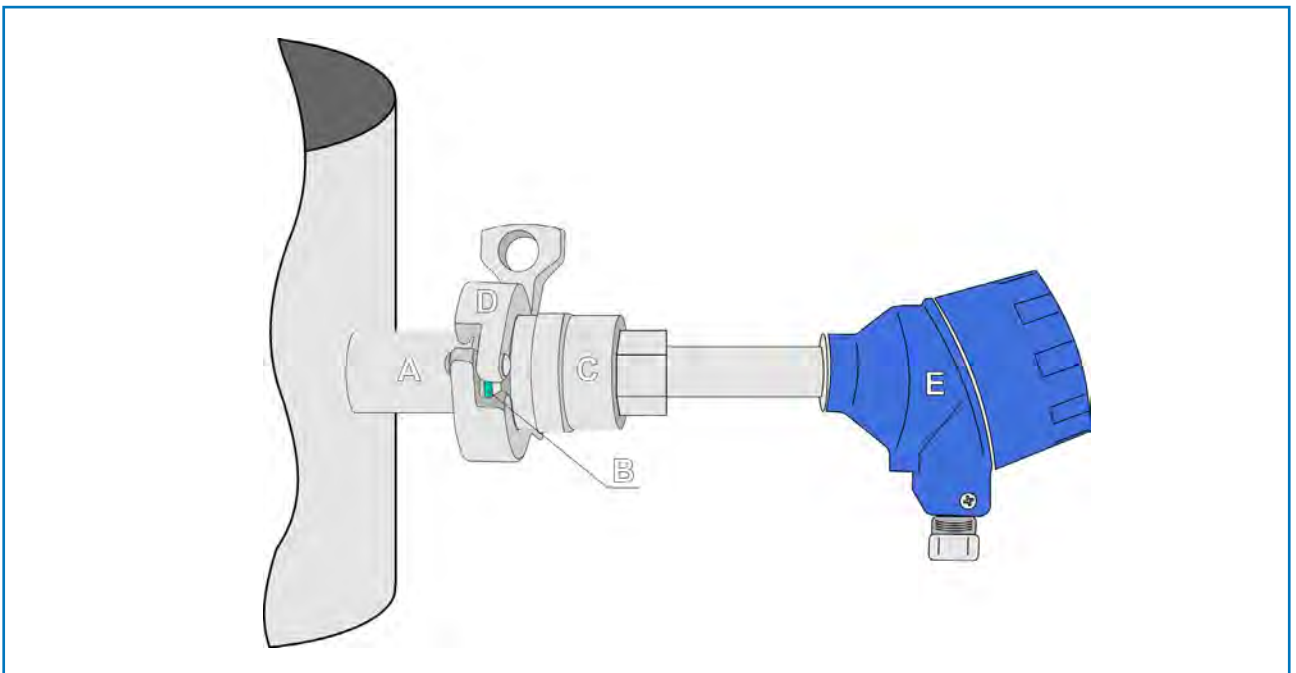

Fig. 3e: Assembled TriClamp

3. Safety

The sensor was designed, built and tested for safety and is shipped in this condition. Components within the supplied system could be hazardous if not unpacked, installed, connected and commissioned by authorised qualified persons. All operating instructions must be read, and understood, before handling the system. Failure to do so will cause the warranty to be revoked.

3.1 Normal use

- The measuring system may only be installed for measuring the low flow rate in metallic pipes.
- Only original spare parts and accessories of ENVEA Process GmbH must be used.

3.2 Identification of hazards

Possible hazards, when using the measuring system, are marked by the following symbols:



Warning!

- This symbolises a situation where personal safety is at risk if used in an improper manner.



Attention!

- This symbolises the possible damage to the system, if used in an improper manner.

3.3 Occupational and operational safety

- ① • The measuring system must be installed by trained and authorised personnel only.
- ⚠ • Protective equipment must be worn to avoid injuries caused by possible sharp edges on the measuring device.
- ① • When using a cable with more than 4 cores, unused, open cores may cause sparking. Failure to comply with the specified connection parameters of the cable will result in loss of intrinsic safety. To prevent this, it is mandatory to use a 4-core shielded cable. Always ensure that the connection parameters of the cable are within the specification (Li, Ci). The shield of the cable must not be connected to the housing under any circumstances.
- ⚠ • When installed in an Ex zone, there is an increased risk of explosion, so it should always be ensured that there is no Ex zone when carrying out installation work.
- ⚠ • Improper installation work leads to an increased risk of explosion. The device must always be installed using the process-related seals and observing the torques. Mechanical stresses are to be avoided, for example through supported installation.
- ⚠ • In case of improper assembly, there is an increased risk of explosion due to escaping dusts.
- ① • Improper mechanical stress (e.g. torsion) can cause damage to the device. To avoid this, the device should always be installed in accordance with all the instructions in the operating manual. The measuring device should also not be exposed to any vibrations if possible.
- ⚠ • If the device is operated under high pressured conditions, there is a risk of explosion. When cleaning or blowing out the pipe and when transporting material, always ensure that the permissible pressure according to the DGRL is not exceeded.

- ⚠ • Due to the process, hot components on the device can cause burns. It is strongly recommended to wear the appropriate protective equipment and to let the device cool down before working on it.
- ⓘ • Improper use of the device will result in a high risk to system safety, therefore the device must only be used as specified in the associated documentation.
- ⚠ • Make sure that the system is in a depressurised state during all maintenance, cleaning and inspection work on the pipelines or on the components of the device.
- ⚠ • In case of maintenance-work on the pipe or on components of the sensor, make sure that the piping is in unpressurized condition.
- ⚠ • Switch off the power supply for all maintenance, cleaning or inspection works on the sensor or on components. Follow the notes of the chapter maintenance.
- ⓘ • Caution, if welding is required on the pipe, remove sensor.
- ⓘ • The components and electrical connections must be checked for damages regularly. If a damage is found, it is to be repaired before further operation of the instruments.

3.4 Maintenance

- ⚠ • For maintenance purposes, it is imperative that the device is de-energised and cooled down, otherwise there is an increased risk of explosion.
- ⚠ • Before working on the device or its components, it is essential to ensure that they are de-energised. Otherwise there is a risk of electric shock.
- ⚠ • The correct tool must be used to open the device, otherwise there is a risk of injury and crushing.
- ⚠ • Before opening the device or its components, it is imperative to ensure that there is no EX zone.
- ⚠ • During cleaning work on the device or in the process, there is an increased risk of explosion due to electrostatic discharges and excessive pressures.

3.5 Technical statement

The manufacturer reserves the right to change any technical data concerning technical developments, without prior notice. If any queries arise, ENVEA Process GmbH will be happy to inform customers of any possible changes made.

3.6 Reliability

For any additional information concerning product reliability, please contact ENVEA Process GmbH.

3.7 Storage conditions

Observe the following instructions during storage:

- To ensure shock resistance, store in original packaging.
- Do not remove protective discs or caps mounted on process connections.
They prevent mechanical damage and contamination to the sealing surfaces.
- Protect from sunlight to avoid impermissibly high surface temperatures.
- Store in a dry and dust-free place.
- Do not store outside.

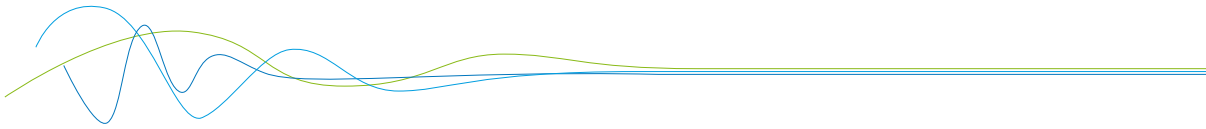

4. Electrical connection

The ProSens has an internal connection chamber with plug-in contacts which can be cabled to suit the appropriate installation options.

Note: For EX versions cat. 1 and 2, the relay contact is only available at the Evaluation unit and not at the sensor.

4.1 Sensor connection

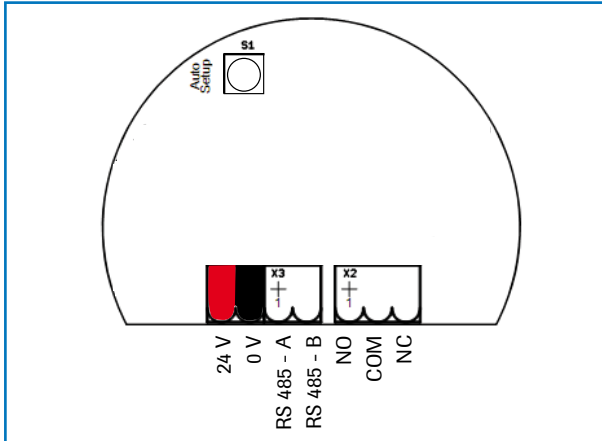

Fig. 4: Electrical connection

Contact no.	Signal
1	V+ (24 V DC)
2	V- (0 V)
3	RS 485 - A
4	RS 485 - B
5	No function
6	No function
7	No function

Tab. 1: Sensor connection

Field housing connection

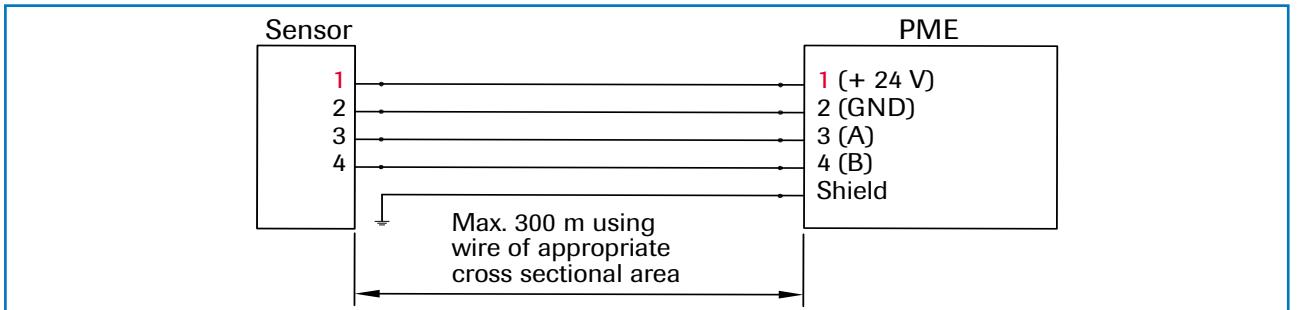

Fig. 5: Field housing connection

DIN Rail connection

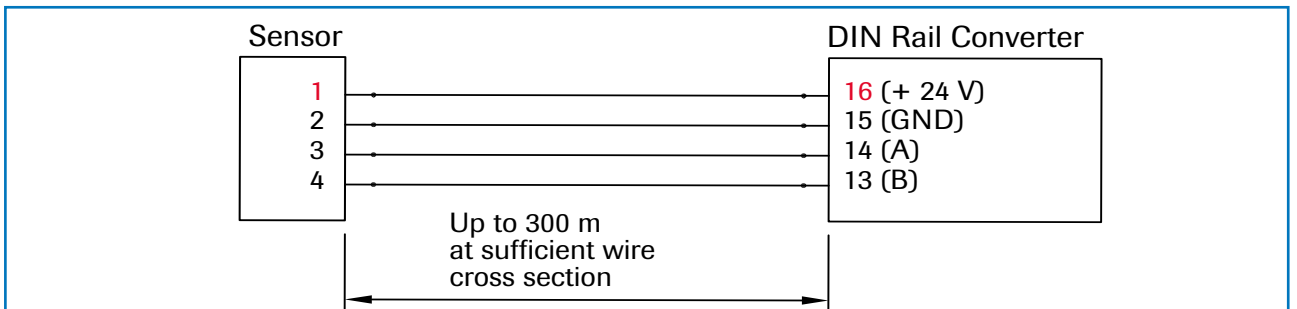
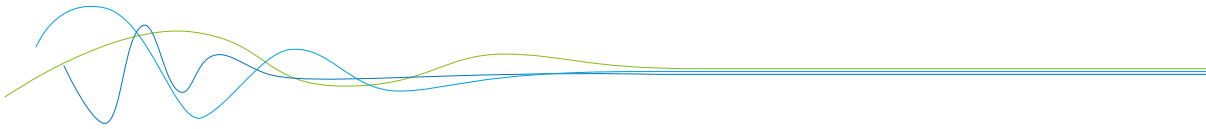

Fig. 6: DIN Rail connection

A cable of type “Ölflex Classic 110 CY” is recommended. The cable should be four wired, twisted and shielded. A minimum cable cross-section of 0.75 mm² should be observed. For distances more than 150 m the cable cross-section should be adjusted. The housing is prepared for DIN Rail mounting according to DIN EN 60715 TH35.



4.2 Field housing MSE 300 Evaluation unit

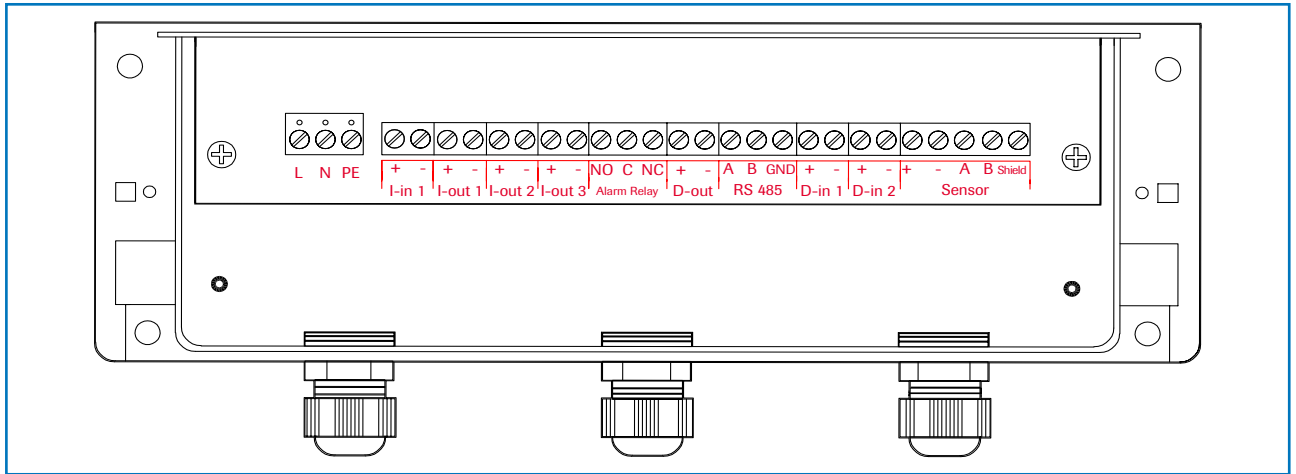
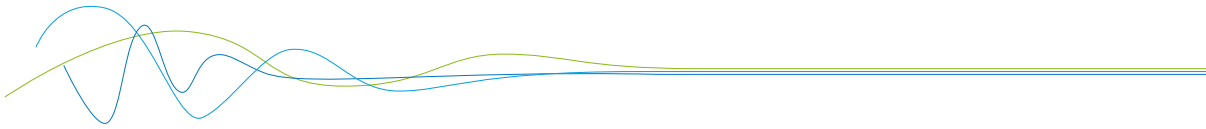

Fig. 7: Electrical connection

Evaluation unit			
Terminal no.	Connection		
Power supply connection			
L / +24 V	Input power supply 230 V / 50 Hz, 110 V / 60 Hz (optional 24 V DC)		
N / 0 V	Input power supply 230 V / 50 Hz, 110 V / 60 Hz (optional 24 V DC)		
PE	Earth		
Connections			
I-in 1	+	Current input +	
	-	Current input -	
I-out 1	+	Current output +	
	-	Current output -	
I-out 2	Na	Not used	
	Na	Not used	
I-out 3	Na	Not used	
	Na	Not used	
Relay	NO	Floating change-over contact NO (make contact)	
	C	Floating change-over contact COM (common conductor)	
	NC	Floating change-over contact NC (break contact)	
D-out 1	Na	Not used	
	Na	Not used	
RS 485	A	RS 485 interface data A (+)	
	B	RS 485 interface data B (-)	
	GND	RS 485 interface ground	
D-in 1	Na	Not used	
	Na	Not used	
D-in 2	Na	Not used	
	Na	Not used	
Sensor	+	Power supply 24 V (+)	Cable no. 1
	-	Power supply 24 V (-)	Cable no. 2
	A	RS 485 data A	Cable no. 3
	B	RS 485 data B	Cable no. 4
	Shield	Shield	Shield

Tab. 2: Field housing connections



4.3 DIN Rail MSE 300 Evaluation unit

1 Current output - 4 ... 20 mA	2 Current output + 4 ... 20 mA	3 Input power supply 0 V DC	4 Input power supply + 24 V DC
5 Not used	6 Alarm relay NC (break contact)	7 Alarm relay COM	8 Alarm relay NO (make contact)

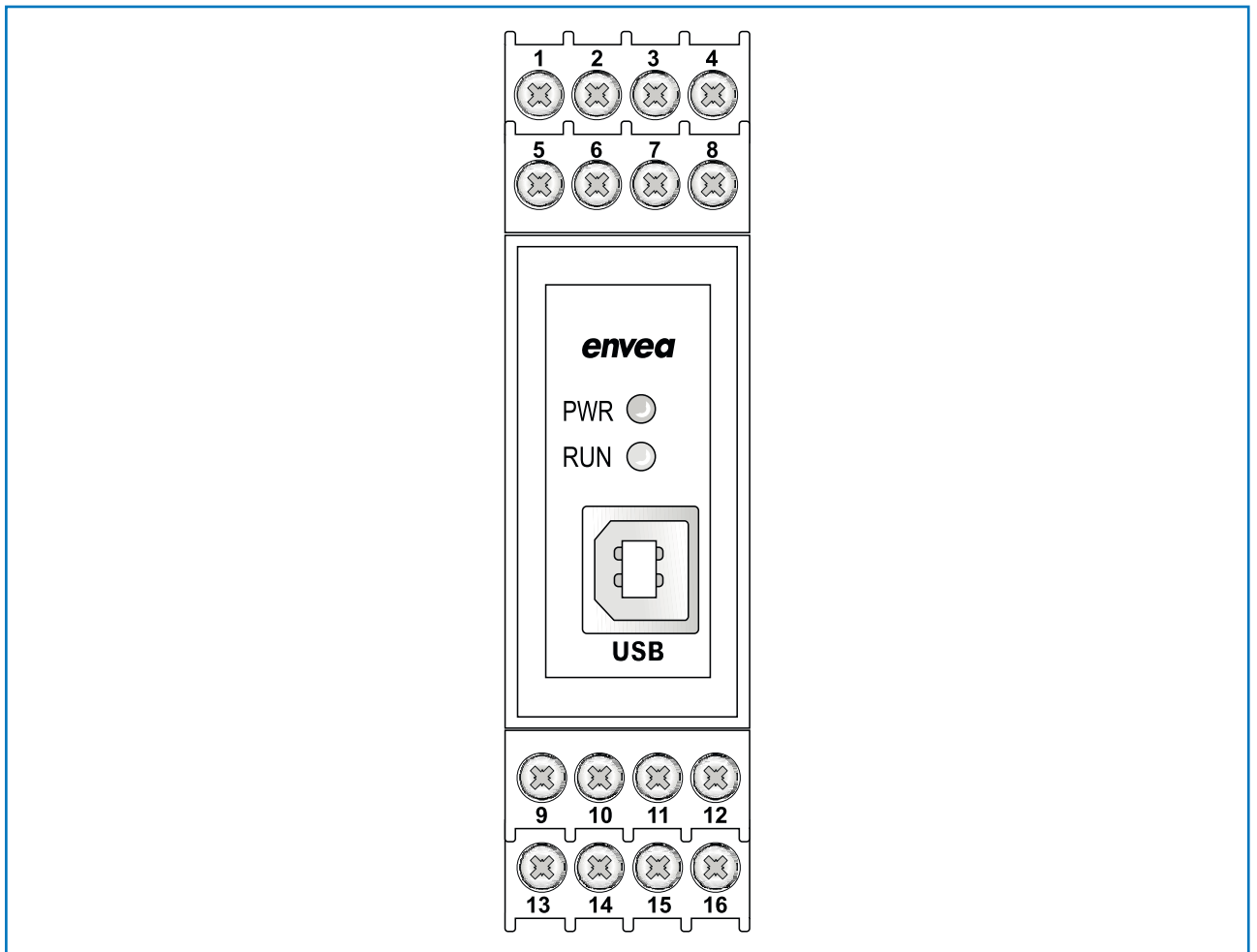

9 Digital pulse output (-)	10 Digital pulse output (+)	11 RS 485- Interface Data B	12 RS 485- Interface Data A
13 Sensor connection Cable 4 RS 485 Data B	14 Sensor connection Cable 3 RS 485 Data A	15 Sensor connection Cable 2 power supply 0 V	16 Sensor connection Cable 1 power supply + 24 V

Fig. 8: DIN Rail connections

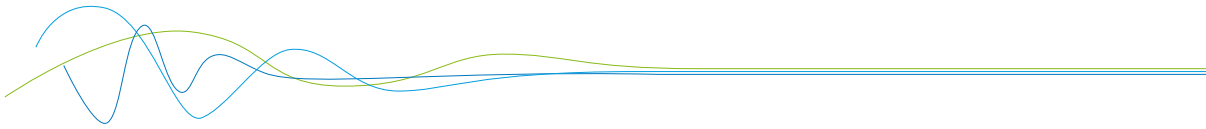

4.4 Connecting multiple sensors using the C3-Box

As an option up to 3 sensors can be connected to the Evaluation unit via the C3-Box to allow large pipe cross-sections to be monitored with accuracy.

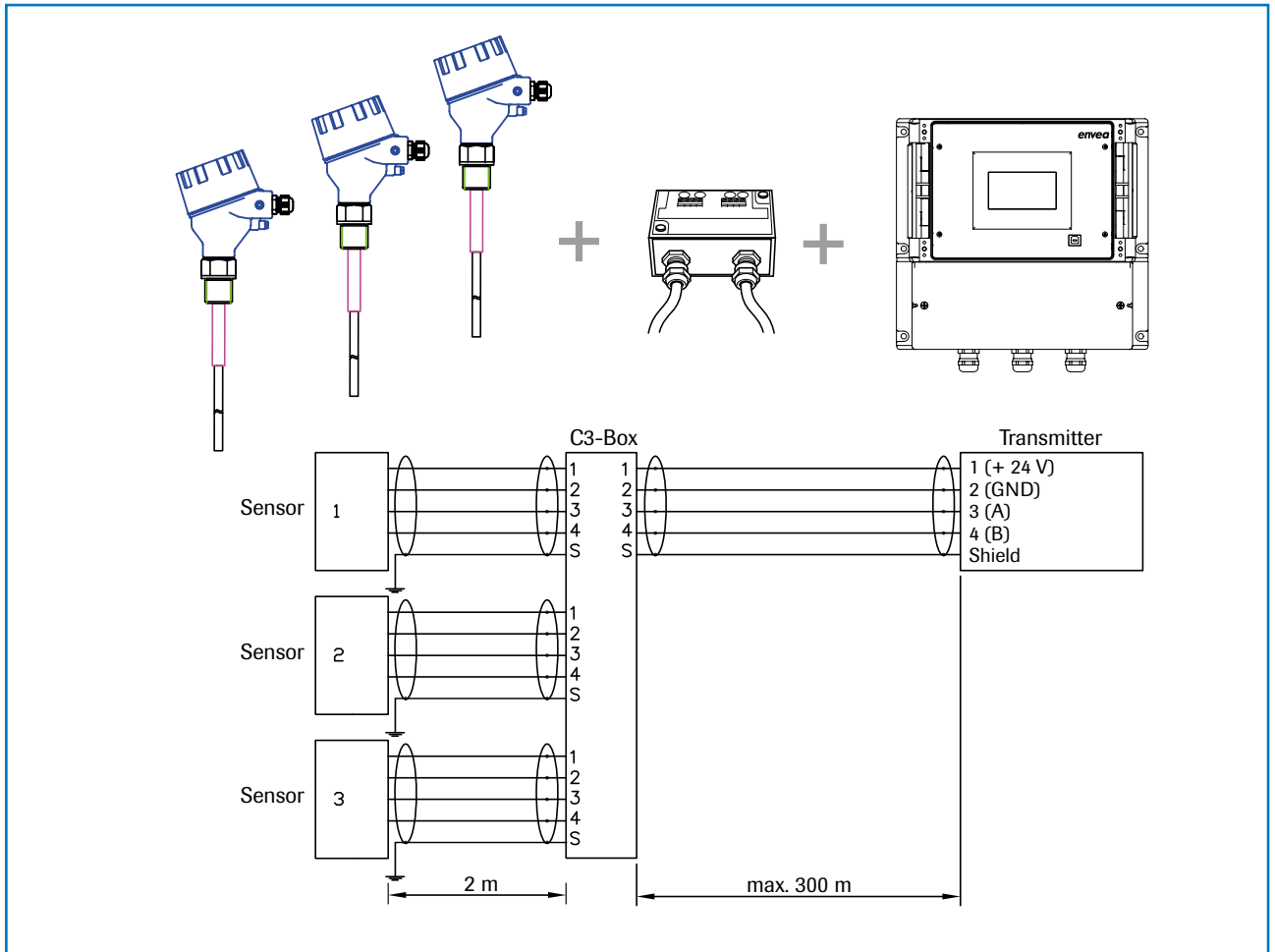

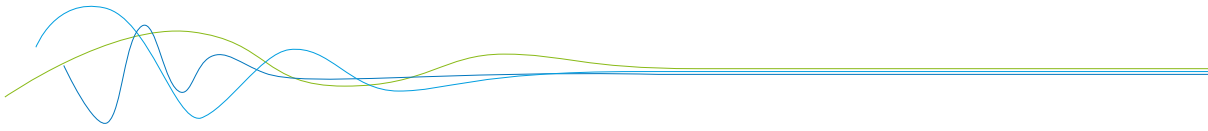

4.5 Use in Ex hazardous areas

The electronics of the sensor are designed to be intrinsically safe with respect to the rod probe. The separation between the intrinsically safe circuit at the rod probe and other parts of the electronics, protected by flameproof enclosure for explosive gas atmospheres and by enclosure for explosive dust atmospheres, takes place within the housing.

With this setup, cabling with intrinsically safe circuits, blue sheathed cables, and blue fittings are **not** required.

All variants starting by those articles codes are concerned.

Example: 50-0003 include 50-0003-HP

Marking DustEx:

ProSens type	
50-0003	⊕ Ex II 3D Ex ia/tb IIIC T150°C Dc
50-0004	⊕ Ex II 1/2D Ex ia/tb IIIC Tx* Da/Db
50-0006	⊕ Ex II 3D Ex ia/tb IIIC T250°C Dc
50-0007	⊕ Ex II 3D Ex ia/tb IIIC T150°C Dc
50-0010	⊕ Ex II 3D Ex ia/tb IIIC T250°C Dc

The electronic enclosure of ProSens Ex may not be installed in dust Ex-areas where intensive charging processes are to be expected.

- Equipment group: 2
- Equipment category: 1/2 Electrode zone 20 / enclosure zone 21 (50-0004)
- Equipment category: 3 Electrode zone 22 / enclosure zone 22 (others)
- For explosive mixtures of air and combustible dusts
- IP-code 68
- Permitted process temperature -20 to 240 °C
- * Up to process temperatures of 120 °C, the maximum surface temperature of the electronic enclosure is 120 °C. In case of higher process temperatures. At higher process temperatures the allowable surface temperature is determined by the process temperature.
- The intrinsic electrode circuit is operated grounded. Lightning protection measures (acc. to IEC/EN 60019-14) for Zone 1 / Zone 20 must be followed by the operator.

Marking GasEx:

ProSens type	
50-0003	⊕ Ex II 3G Ex db ia IIC T3 Gc
50-0004	⊕ Ex II 2G Ex db ia IIC T4* Gb
50-0006	⊕ Ex II 3G Ex db ia IIC T2 Gc
50-0007	N/A
50-0010	⊕ Ex II 3G Ex db ia IIC T2 Gc

The sensor is not allowed to be used in areas of class IIC, in case of expected, intense charging processes.

- Equipment group: 2
- Equipment category: 2 Electrode and enclosure zone 1 (50-0004)
- Equipment category: 3 Electrode and enclosure zone 2 (others)
- For explosive mixtures of air and combustible dusts
- IP-code 68
- Permitted process temperature -20 to 240 °C
- * Up to process temperatures of 130 °C, the sensor corresponds to temperature class T4.
At process temperatures up to 195 °C, the sensor corresponds to temperature class T3 and at process temperatures up to 240 °C, the sensor corresponds to temperature class T2.
- The intrinsic electrode circuit is operated grounded. Lightning protection measures (acc. to IEC/EN 60019-14) for Zone 1/Zone 20 must be followed by the operator.

4.6 Related standards

ATEX (BVS 13 ATEX E 096 X or self certified)
 EN IEC 60079-0: 2018
 EN 60079-1: 2014
 EN 60079-11: 2012
 EN 60079-31: 2014

4.7 U_m

U_m (Supply) = 26.5 V

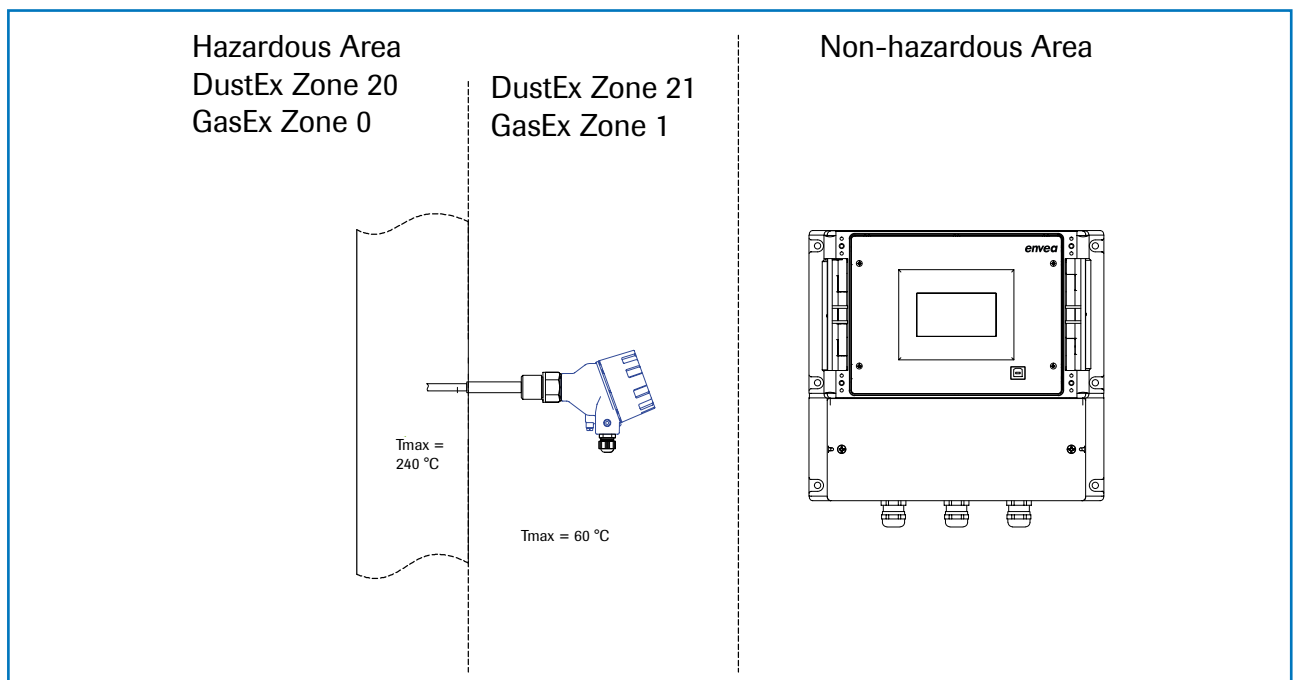

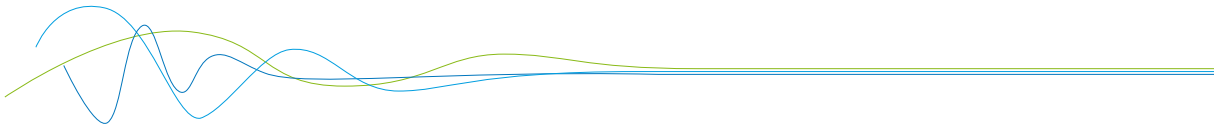

5. Dimensions

5.1 Sensor

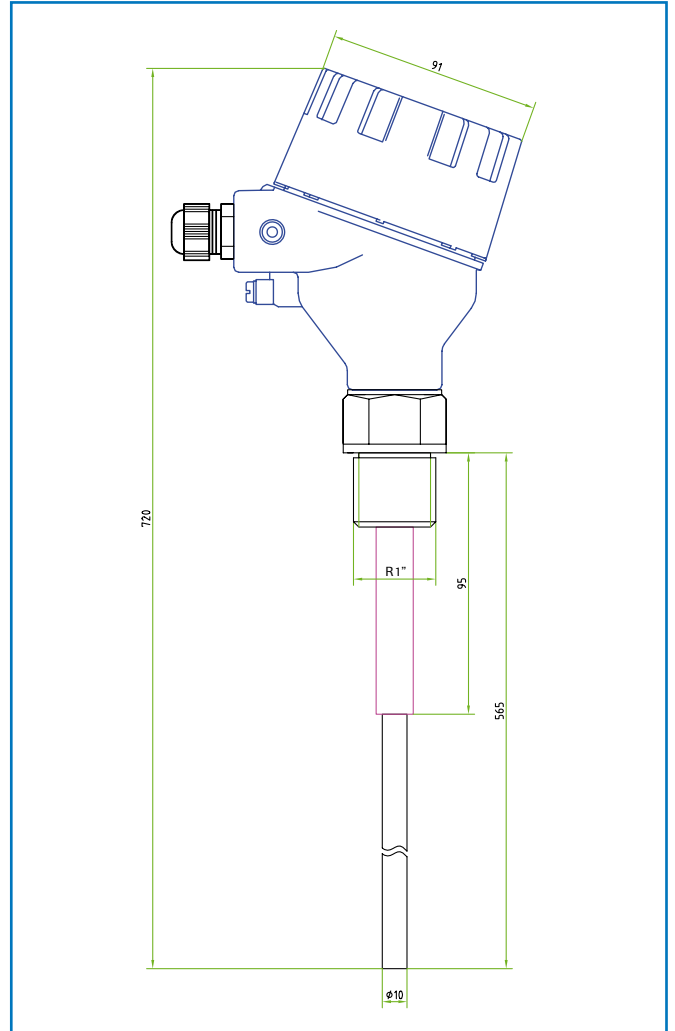

Fig. 11: ProSens / ProSens Ex dimensions

5.2 Field housing Evaluation unit

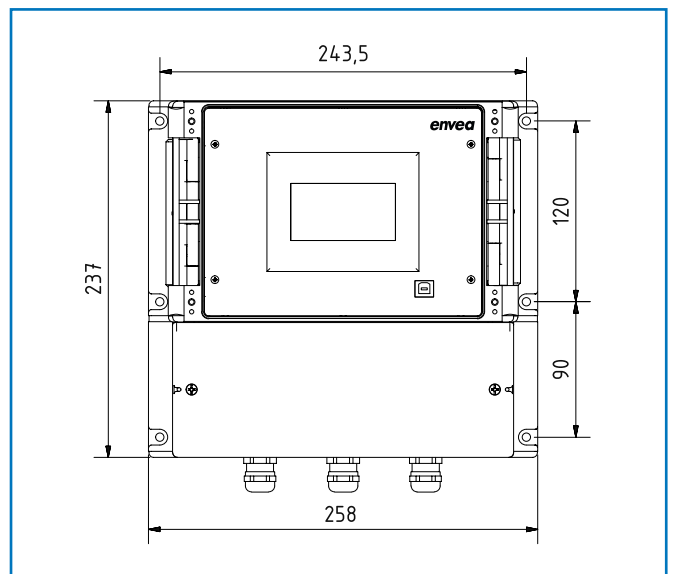

Fig. 12: Field housing for the Evaluation unit

5.3 DIN Rail Evaluation unit

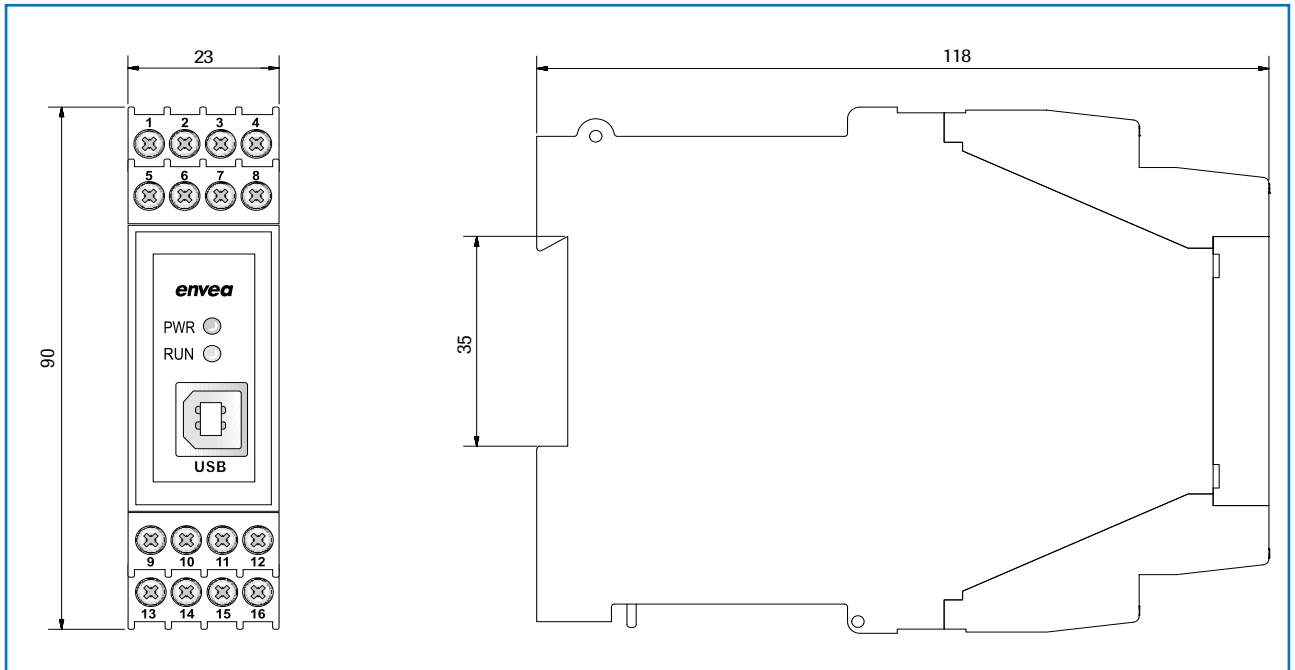

Fig. 13: DIN Rail dimensions

5.4 C1-Box dimensions (optional)

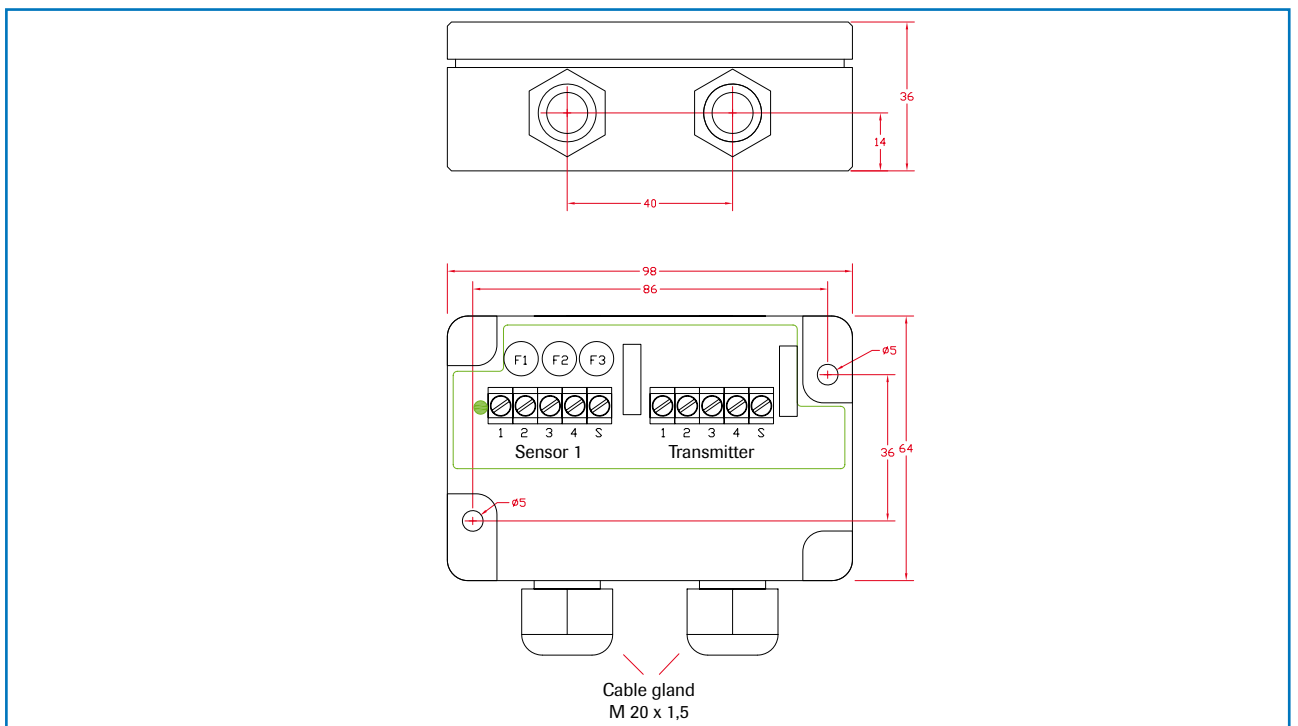
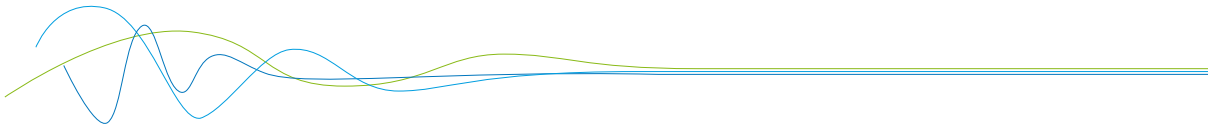

Fig. 14: C1-Box dimensions



5.5 C3-Box dimensions (optional)

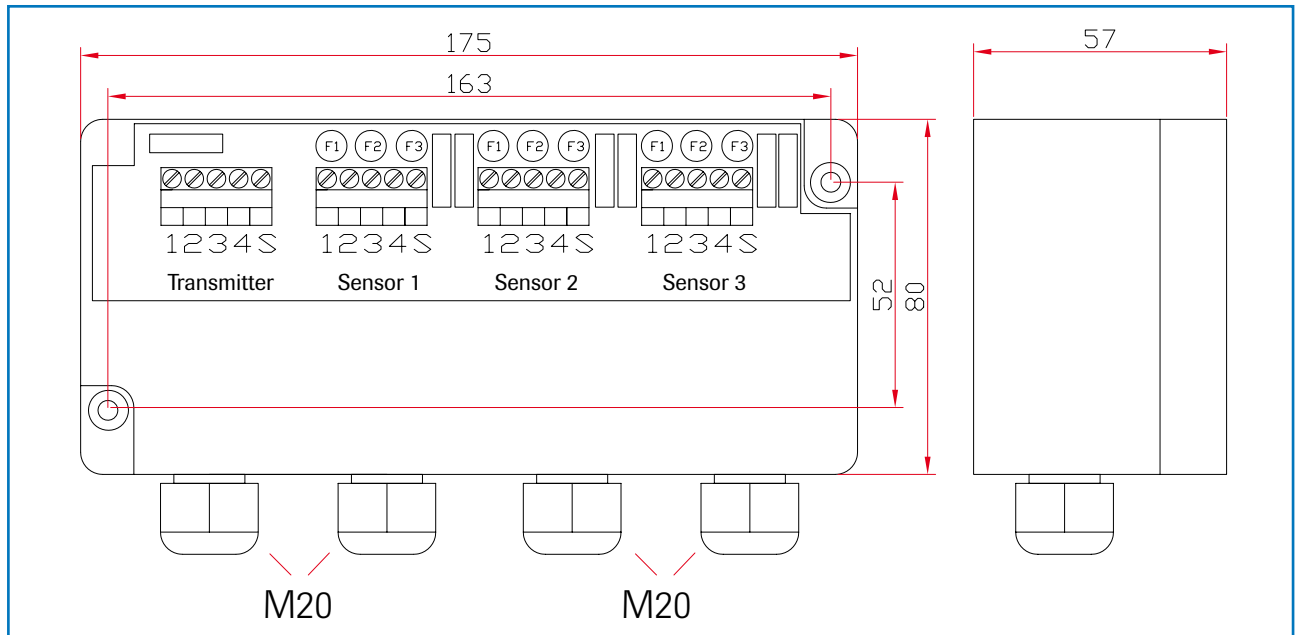

Fig. 15: C3-Box dimensions

6. Operation

The ProSens dust measuring instrument measures the dust content in a gas passing the sensor using the electrodynamic principle by means of the exchange of charge carriers between the dust particles and the sensor's probe.

After switching on, the ProSens already begins to measure with the default factory settings.

Commissioning can be carried out at the Evaluation unit MSE 300 optionally via the touchscreen or with the configuration software. Only PC configuration is possible for the DIN Rail version. **The menu structure or numbering is identical for touchscreen and PC configuration, which means the detailed description for this applies to both versions in this operating manual. Any deviations from this will be explained separately.**

6.1 Basic operation of the touchscreen (only field housing)

To start the configuration menu, the top right half of the touchscreen needs to be pressed for a few seconds.

The main overview with software version number as well as four operating keys appears on the right of the screen.

- Up key
- Down key
- C key (e. g. also E key)
- Enter key

Press the Up or Down key to navigate in the menu, or the Enter key to enter a submenu item. To quit a submenu or the entire configuration menu, press the C key (Cancel), likewise to cancel an entry or selection. The can also be the E key (Escape), depending on the menu or function.

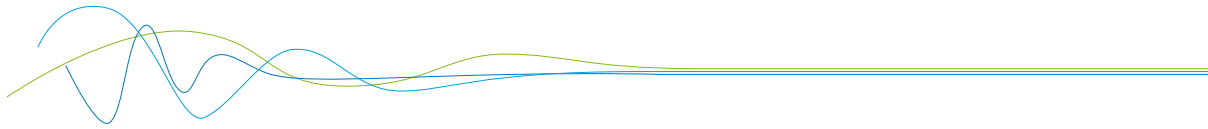

6.2 Basic information on the user interface

The operator interface differs depending on the system design:

- DIN Rail housing without display, operation via PC software
- Field housing with display, alternative operation via PC software
- One to three sensor system

First of all, the different system versions are described below. Following that, the basic operation of the ProSens system as a one sensor system is then described without going back over the different versions.

6.3 Differences between the DIN Rail and field housing Evaluation unit

The Evaluation unit in the DIN Rail housing is only a part of the functions available in the field housing.

The ProSens with converter only supplies one dust trend signal.

The following overview clarifies the differences between the versions.

Function	Field housing	DIN Rail	Converter
Menu system			
• via PC software	yes	yes	yes
• via display	yes	no	no
Measurement value display current output	yes	yes	yes
Pulse output for measurement value output	yes	yes	no
Alarm system relay output	yes	yes	yes
Remote control digital input	yes	no	no
Cleaning pulse	yes	yes	no
Autocorrect analogue input	yes	no	no
Error output			
• on current output	yes	yes	yes
• at relay	yes	yes	yes
• via PC software	yes	yes	yes
• via display	yes	no	no
• at status LED	no	yes	yes
Measurement value output mg/m³ or %	yes	yes	no

The Evaluation unit in the DIN Rail can only be configured via a USB or Modbus RS 485 interface and PC program. On the Evaluation unit in the field housing, all functions can be configured by menu via the touch-sensitive display. The field housing Evaluation unit can also be configured by PC.

The menu items on the display and in the PC software are numbered in a uniform manner so that they can be referred to later on.

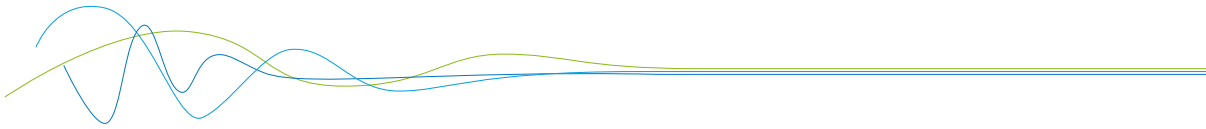

6.4 Display

The display is touch-sensitive. Available keys are displayed directly in context. When the measuring system is first started, a query is initiated to select the language and sensor.

If no selection is made, the initialization disappears and the German language with a SolidFlow 2.0 sensor is selected.

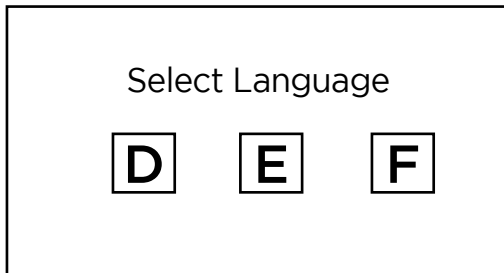

Initialization screen when the Evaluation unit in the field housing started first time.

Selection of the menu language:

Deutsch, English, Français

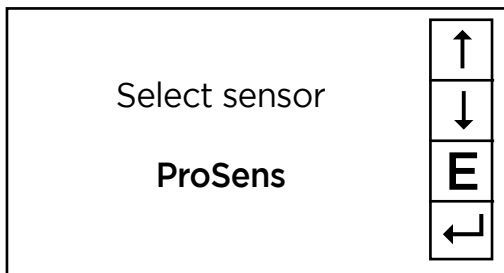

If a language has been selected, the sensor to be used must be selected.

To be available:

SolidFlow 2.0, Paddy, PicoFlow, MaxxFLOW HTC, DensFlow, SpeedFlow 2.0, SlideControl 2.0, ProSens, M-Sens 3, M-Sens 2, M-Sens WR3, AirFlow P.

Afterwards the start page appears.

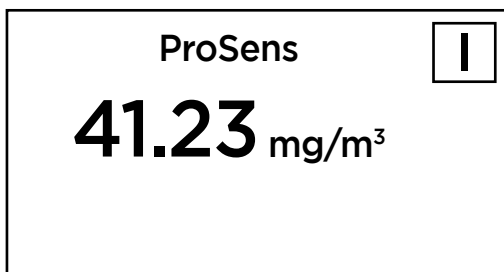

The start page display the following values:

- Tag No "ProSens", freely selectable text which describes the material or the measuring point
- Measurement, here in mg/m³
- [I] key for info

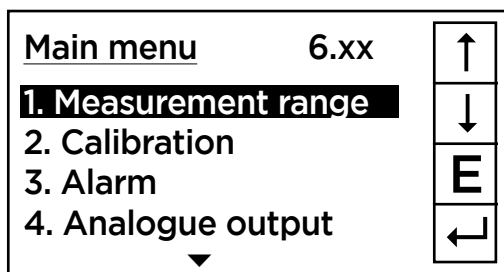

To access the menus, press and hold any area of the display for several seconds.

The sub-menu selection will be displayed:

In the menus and input fields, the displayed keys can be used to browse, select, edit or reject:

- Arrow: Scroll down the page, Select an option, Select a position in the input text
- [E] for ESC: Interrupt the function without making any changes
- [←]: Select the function or confirm the input
- [C] for Clear: Delete a symbol or number.

Sensor Status			
	Temp	Raw value	Stat
S1	---	0.000123	OK
S2	---	0.000213	OK
S3	---	0.000321	OK
Average		0.000219	

With the key [I] you can choose between different information windows. The first window shows the raw values, temperature and the status of the sensor. The second window displays the error memory. Recent error codes always come first. If an error code is repeated, it will appear first, but will not be listed multiple times.

Save changes?

Y
N

If any data has been changed, the change will only be taken into account when you exit the complete menu structure and answer [Yes] when asked if you wish to save the changes.

For reasons of simplicity, a further display menu screen has been dispensed with. The display screens are directly derived from the menu structure in section 6.5.

Protection against unauthorised use:

If a password has been entered in menu **7. System** in **7.6 Password**, which is different to the “0000” default setting, you will be asked to enter a password when attempting to access the menus. After the password has been successfully entered, the menus will be unlocked for approx. 5 minutes (from the last menu entry).

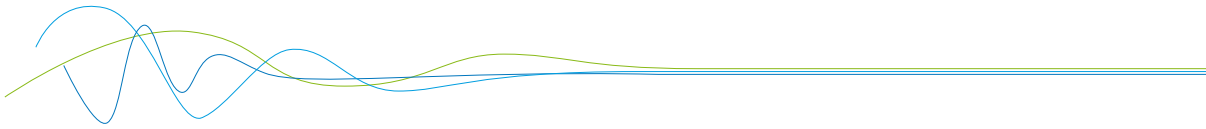

6.5 PC interface

Communication with a laptop or PC occurs optionally at the terminals via an RS-485 interface or on the front via a USB interface, with the simple ProSens converter as well as with the Evaluation unit in DIN Rail or field house version.

- ✓ The **RS 485 connection** is attached to the Evaluation unit in the field housing at the Modbus A (+) and Modbus B (-) terminals. On the DIN Rail version, these connections are no. 12 and 11, accordingly.

RS 485 is a bus connection; the Modbus address and the baud rate can be set on the device. Upon delivery, the communication parameters are set to:

- Modbus address 1
- Baud rate 9600, 8, E,1

An RS 485 to USB adapter can be purchased from ENVEA Process.

- ✓ A standard USB-A-B cable is supplied for the USB connection. The USB connection is a point-to-point connection that is BUS-enabled. The Modbus address and baud rate for the front connections cannot be changed and are always:

- Modbus address 1 (or the device answers to all addresses)
- Baud rate 9600, 8, E,1

When connected to the PC for the first time, any interface drivers enclosed with the Evaluation unit must be installed.

After starting the software, the communication parameters must first be entered accordingly. These can be found in the top left of the program window.

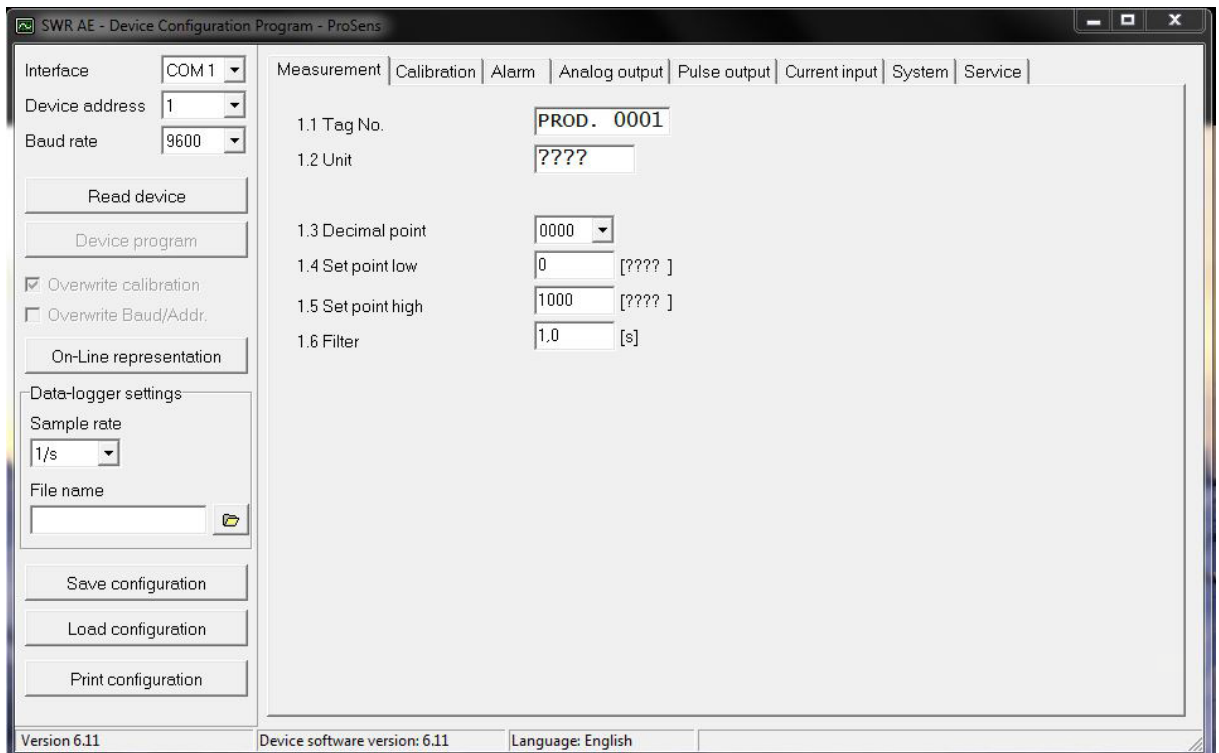

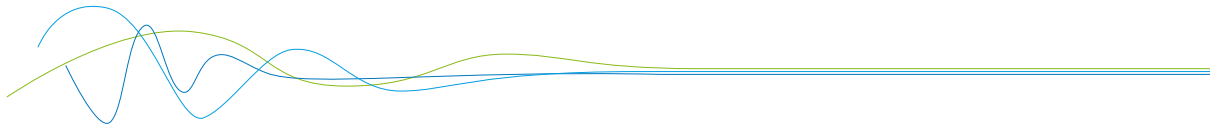

Communication is established by clicking on “Read device”. The acknowledgement message “Parameter read in” is displayed. If an error message is displayed instead, check the communication parameters and cable connections between the PC and the Evaluation unit.

The edited data is transmitted to the Evaluation unit via “Program device”. Critical data concerning the Modbus communication and the calibration must be confirmed before the parameters are transmitted to the Evaluation unit:

- ✓ If, when saving the the parameters in the Evaluation unit, the system calibration data is changed, this action must be confirmed by checking “Overwrite calibration”.
- ✓ If, when saving the the parameters in the Evaluation unit, the system interface parameters are changed, this must be confirmed by checking the selection “Overwrite baud rate address”.

In addition, with the PC software,

- the parameters of the Evaluation unit can be saved in a file (“Save configuration”)
- the parameters of the Evaluation unit can be loaded from a file (“Load configuration”)
- the parameters of the Evaluation unit can be printed via the set Windows standard printer (“Print configuration”)
- the measured values can be logged in a data logger file (enter the file name and storage rate, and activate the data logger on the online display)

The software language can be set by right-clicking the “Sprache/Language/Langue” field in the bottom program line on “Deutsch/English/Français”.

Protection against unauthorised use:

The PC interface does not have a password prompt as it is assumed that only authorised personnel will have access to the PC and the software. However, the password to operate the display can be read and changed in menu **7. System** under **7.6 Password**.

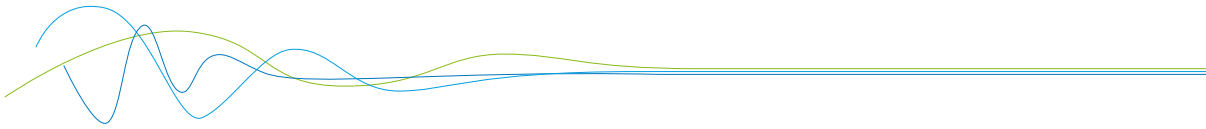

6.6 Menu structure

The menu structure supports the user when adjusting the measuring range, the calibration, the measurement values and the choice of additional functions. In this connection, the numbering both on the display and in the PC interface is identical:

Tab 1: Measurement range

Setting all relevant measuring range settings.

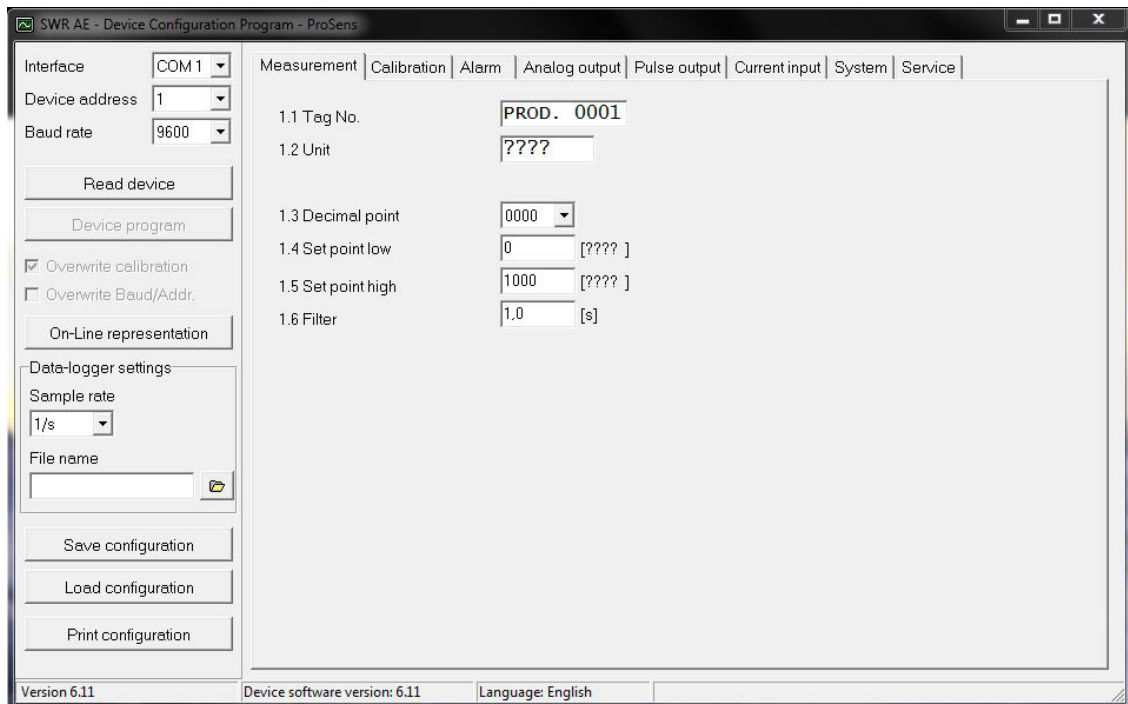

1.1 Tag No.	Input: Free text (10 characters)	Name of the measurement point or product.
1.2 Unit	Input: Unit text, e.g. kg	Required mass flow unit.
1.3 Decimal point	Selection: 0000, 0.000, 00.00, 000.0	Number representation and decimal point-accuracy in the measurement menu.
1.4 Set point low	Input: 0 ... 9999	Throughput rates under this value will not be displayed at the current output. This does not concern the display indicator, totaliser or pulse output.
1.5 Set point high	Input: 0 ... 9999	Throughput rates above this value will not be displayed at the current output. This does not concern the display indicator, totaliser or pulse output.
1.6 Filter	Input: 0.0 s ... 999.9 s	Filtering of measurement for the indicator and the output values.

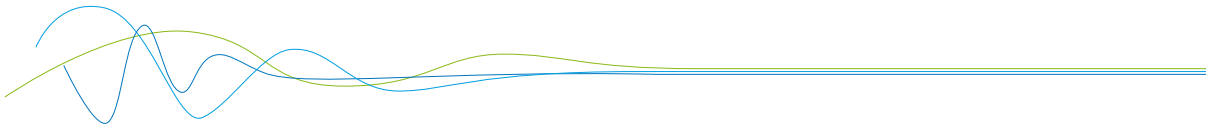

Tab 2: Calibration

(Differences between the field housing and software now result here.)

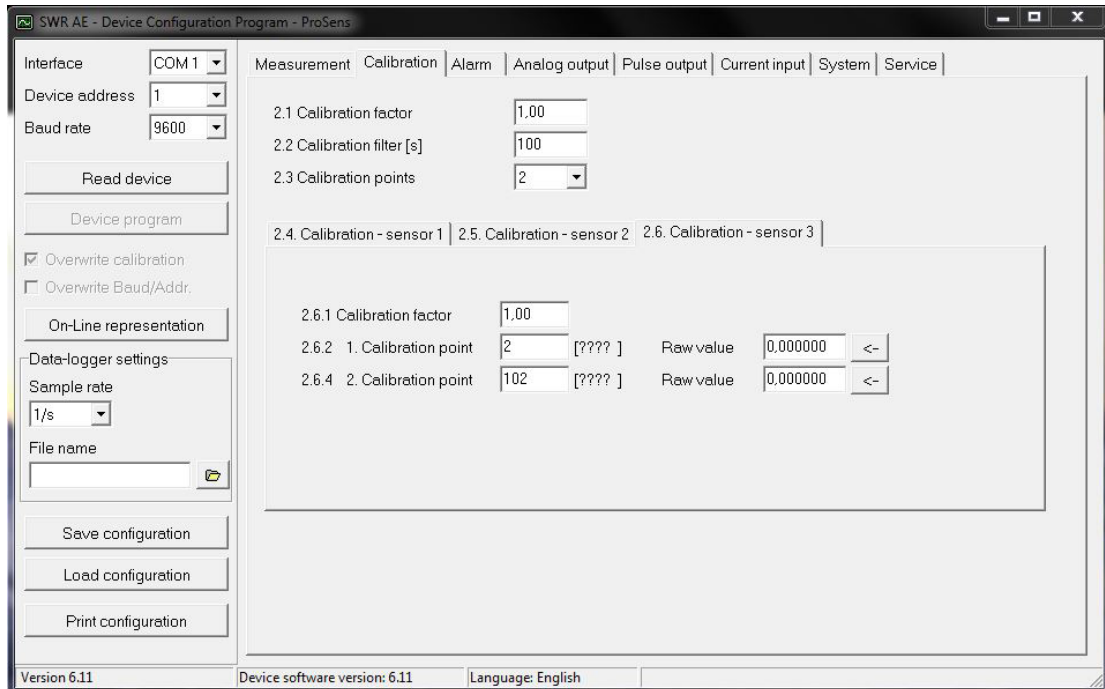

2.1	Calibration factor	Input: 0.01 ... 99.99	Adjustment of the measurement value, multiplies the (Field housing and software) calibrated measurement value, serves for subsequent correction of the calibration.
2.2	Calibration filter [s]	Input: 1 ... 9999	Quiescent filter for the calibration log.
2.3	Calibration points	Input: 2 ... 5	Selection of the calibration points in the calibration table.
2.4	Calibration	Calibration submenu	
2.4.1	P1 value	Input: measurement value to be shown	Output measurement value in the selected mass / time unit.
(2.4.2)	P1 calibration	Adoption: Raw value current raw value	Adoption of the instantaneous raw value (filtered) from the mass flow with the key []. The value can also be entered manually.
	... (depending on the number of support points)		For additional support points (depending on [2.3]), additional value pairs can be set.

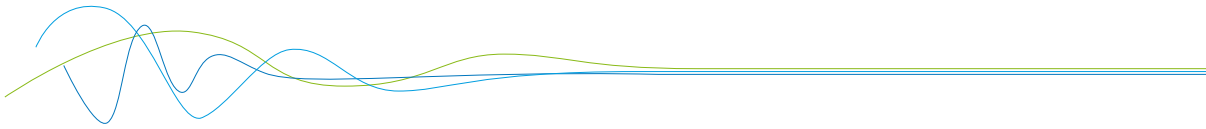

Tab 3: Alarm

Setting for the alarm via the relay contacts.

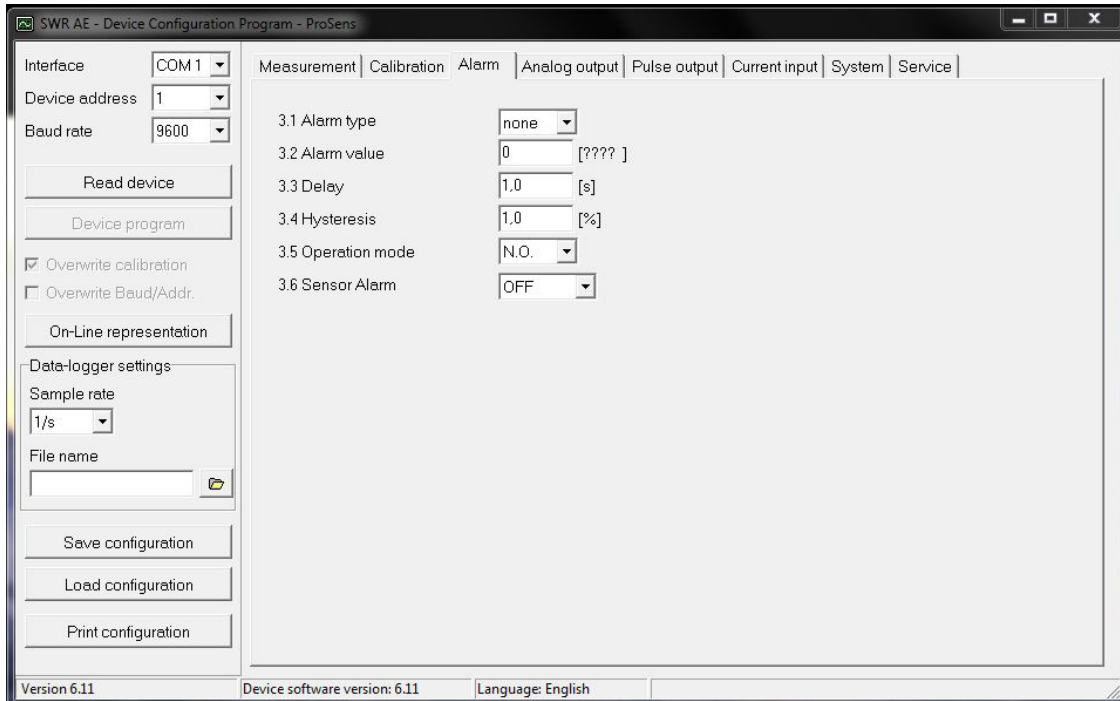

3.1	Alarm type	Selection: Min / Max / None	Maximum alarm (Exceeding the alarm threshold value) or Minimum alarm (Falling below the alarm threshold value).
3.2	Alarm value	Input: 0 ... 999.9 in the selected unit	limit value for monitoring Min. or Max.
3.3	Delay	Input: 0.1 ... 99.9 s	The value must permanently exceed or fall below the set limit during this time.
3.4	Hysteresis	Input: 0.1 ... 99.9 %	The alarm continues for as long as the measurement is not smaller or larger than the limit value plus or minus hysteresis.
3.5	Operation mode	Selection: Working / closed-circuit principle	NC: the relay is closed while there is no alarm. NO: the relay is closed, if there is an alarm.
3.6	Sensor alarm	Selection: OFF /ERR / PROC	Off: Sensor or process indicators are not displayed at the relay. ERR: Serious internal sensor errors trigger an alarm at the relay PROC: Serious internal sensor errors and process indicators trigger an alarm at the relay. Further information on the signalling levels ERR or PROC can in Chapter Troubleshooting.

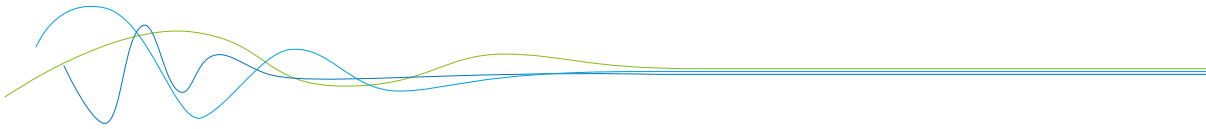

Tab 4: Analogue output

Setting and calibrating the analogue output.

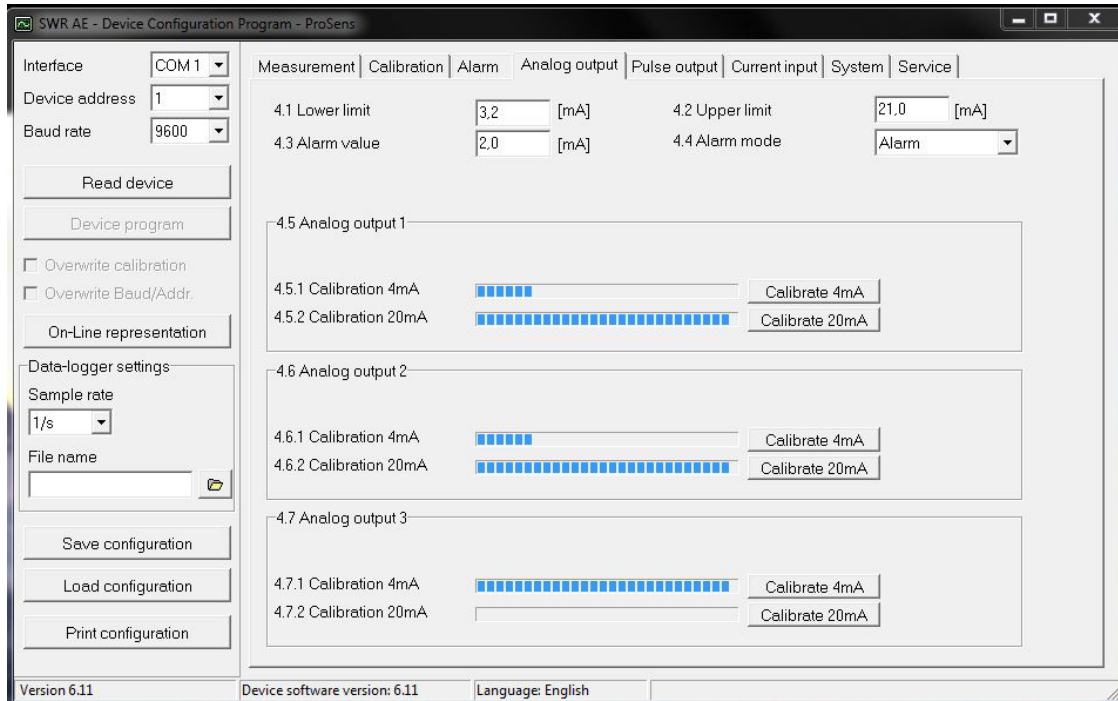

4.1	Lower limit	Input: 0 ... 22 mA	Standard setting: 3.2 mA
4.2	Upper limit	Input: 0 ... 22 mA	Standard setting: 21 mA
4.3	Alarm value	Input: 0 ... 22 mA	Value to be output at pending alarm (Standard setting 2 mA)
4.4	Alarm mode	Selection: Hold alarm / output	Alarm: Alarm is output. Measurement value drops to 0, or current measurement value. Hold output: Last measurement value remains pending until fault rectification at the output signal.
4.5	Analogue output 1	Submenu	
4.5.1	Calibration 4 mA	Selection: Setting the output current	Key functions can be used to set the current and equalise it to the receiver side.
4.5.2	Calibration 20 mA	Selection: Setting the output current	Key functions can be used to set the current and equalise it to the receiver side.
4.6	Analogue output 2	Submenu	
4.6.1	Calibration 4 mA	Selection: Setting the output current	Key functions can be used to set the current and equalise it to the receiver side.
4.6.2	Calibration 20 mA	Selection: Setting the output current	Key functions can be used to set the current and equalise it to the receiver side.

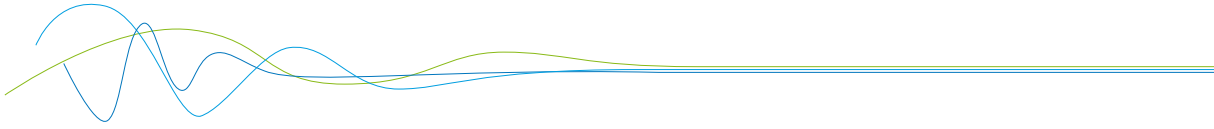

4.7 Analogue output 3 **Submenu**

4.7.1 Calibration 4 mA **Selection:** Key functions can be used to set the current
Setting the output current and equalise it to the receiver side.

4.7.2 Calibration 20 mA **Selection:** Key functions can be used to set the current
Setting the output current and equalise it to the receiver side.

The current output can be calibrated so that the zero point (output of 4 mA) is set to the background noise of the measuring point. If the background noise drops owing to process changes, deposits on the sensor or other effects of ageing, less than 4 mA is output and the zero point offset can be detected. (Zero point drift)

If this function is not desired for process engineering reasons, the zero point must be specified for the calibration to a raw value of zero and/or the MIN limit (**4.1**) set to 4 mA.

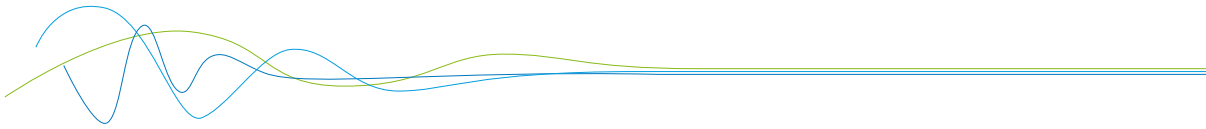

Tab 5: Pulse output

Passive signal for pulse cleaning or output of a totalisator.

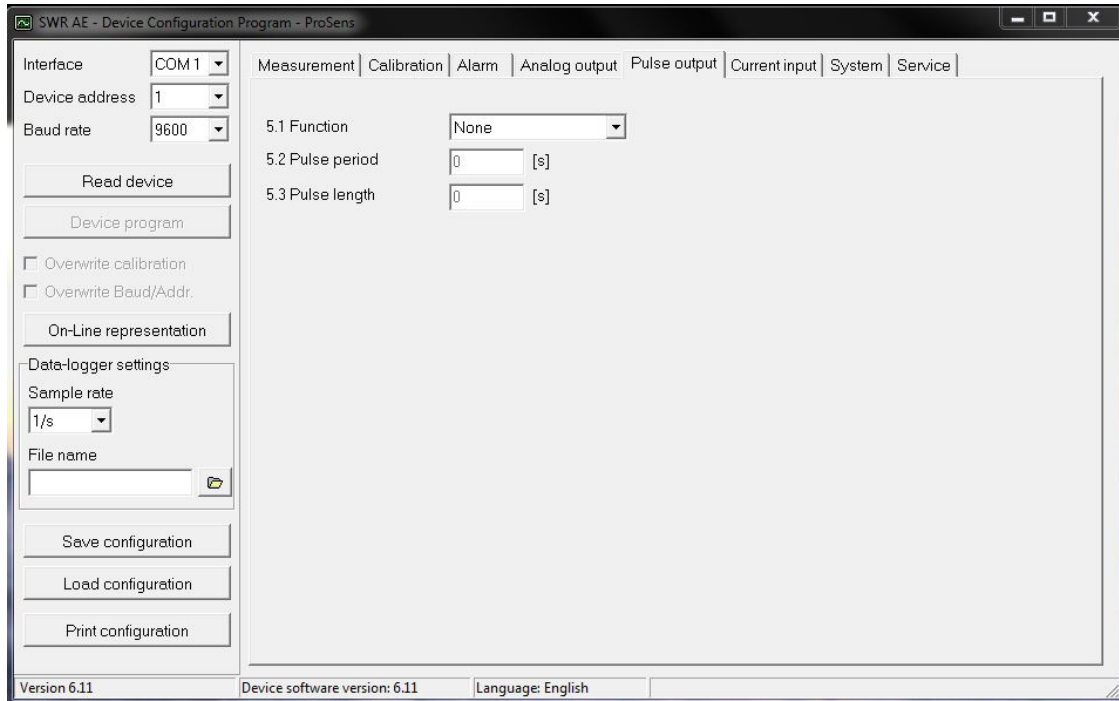

5.1	Function	Selection: OFF / Cleaning / Quantity pulse	OFF: No pulse output Cleaning: Option for actuation of a solenoid valve for pneumatic air flushing.
5.2	Pulse period	Input: 1 s ... 600 s	Duration between two pulses
5.3	Pulse length	Input: 1 s ... 60 s	Length of the pulse

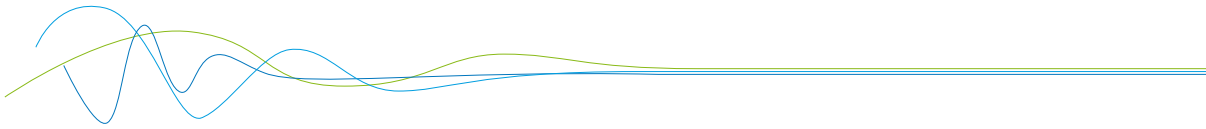

Tab 6: Current input

Option for auto-correction by external current signal. The signal is not electrically isolated.

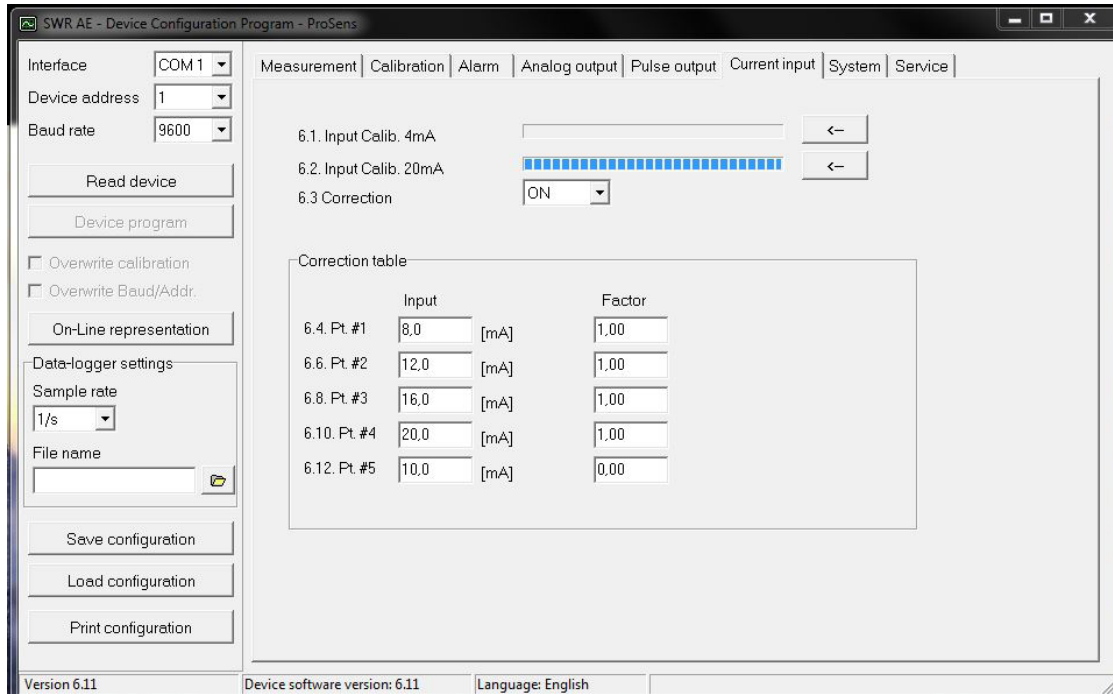

6.1	Calibration 4 mA	Selection: Set input current	The 4 mA signal can be read in via key functions.
6.2	Calibration 20 mA	Selection: Set input current	The 20 mA signal can be read in via key functions.
6.3	Correction	Selection: ON / OFF	ON: Activation of the correction. OFF: Deactivation of the correction.
6.4	P1 input	Input: 4 mA ... 20 mA	Entry of the current that is to be used for the correction.
6.5	P1 factor	Input: 0.01 ... 10	Factor for subsequent adjustment of the actual measurement value.
6.n	Pn input	Input: 4 m A ... 20 mA	Option for further entry of current value and correction factors.
6.n	Pn factor	Input: 0.01 ... 10	

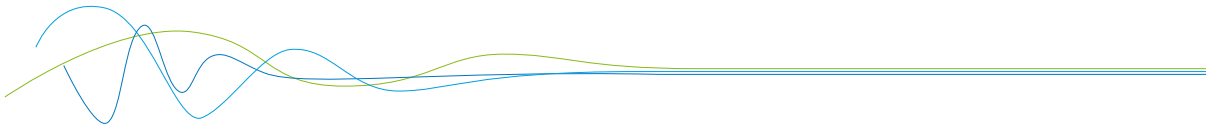

Tab 7: System

Basic settings of the system and Evaluation unit.

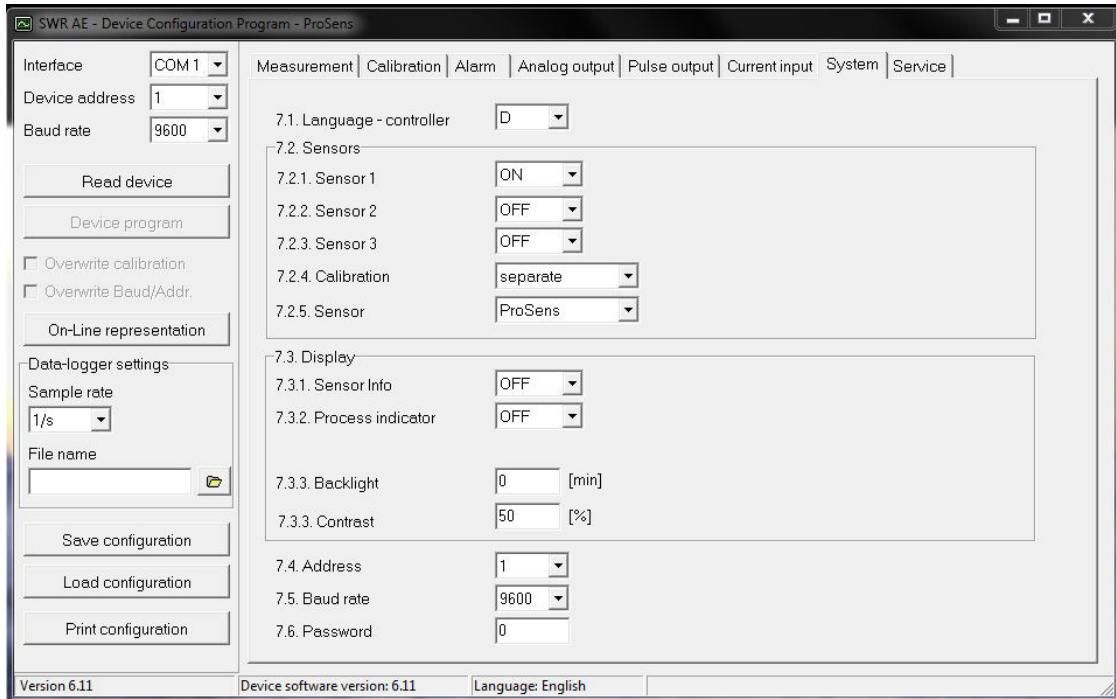

7.1	Language	Selection: D / E / F	Selection of the language on the display of the Evaluation unit.
7.2	Sensors	Special functions and calibration	
7.2.1	Sensor 1	Selection: ON / OFF	ON: Sensor is evaluated OFF: Sensor is ignored
7.2.2	Sensor 2	Selection: ON / OFF	ON: Sensor is evaluated OFF: Sensor is ignored
7.2.3	Sensor 3	Selection: ON / OFF	ON: Sensor is evaluated OFF: Sensor is ignored
7.2.4	Calibration	Selection: Individual / Average value	Function only for multiple sensor systems! Individual: Each sensor is calibrated via an individual calibration table. This is followed by a throughput calculation based on the throughput values of the individual sensors. (This function should only be used by trained ENVEA Process personnel.) Average value: The average value from all sensors used is saved for calculating the throughput in a common calibration table.

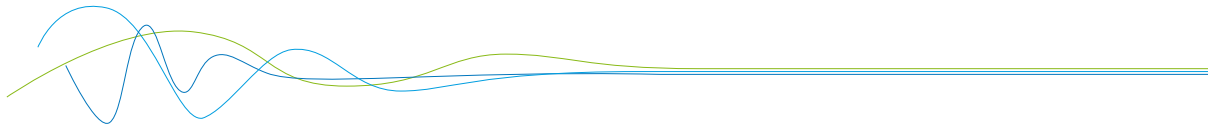

7.2.5	Sensor	Selection: SolidFlow 2.0 / PicoFlow / ProSens / SpeedFlow 2.0 / Paddy / MaxxFlow HTC / DensFlow / SlideControl / M-Sens 2 / M-Sens 3 / M-Sens WR3 / AirFlow P	<p>The Evaluation unit checks whether the connected sensor corresponds to the set sensor.</p> <p>The measurement values are calculated and potential errors are displayed based on the set sensor.</p> <p>Incorrect sensor selection leads to communication denial.</p>
7.3	Display		
7.3.1	Sensor info	Selection: ON /OFF	<p>ON: The key for querying sensor information is shown on the display.</p> <p>OFF: The key for querying sensor information is hidden on the display.</p>
7.3.2	Process indicators	Selection: ON /OFF	<p>ON: Process indicators are shown on the display and indicated on the DIN Rail by flashing twice.</p> <p>OFF: Process indicators are not output.</p>
7.3.3	Backlight	Input: 0 min ... 99 min	<p>Display lighting in minutes</p> <p>0 = Permanent lighting</p> <p>99 = Time selection for lighting</p>
7.3.4	Contrast	Input: 0 ... 100 %	<p>In the event of an inadequate display, the contrast can be changed via the PC software, if necessary.</p>
7.4	Address	Input: 1 ... 255	<p>Modbus address of Evaluation unit, if this is operated on a PLC or PC as a Modbus slave (RS485 connection).</p>
7.5	Baud rate	Selection: 4800 / 9600 / 19200 / 38400	<p>Communication speed of the Evaluation unit if operated on a PLC or PC as a Modbus slave.</p>
7.6	Password	Input: 0 ... 9999	<p>0 = No password protection</p> <p>XXXX = Four digit password that is queried when calling up the menu on the display.</p> <p>Automatic locking for five minutes after the last display input.</p>

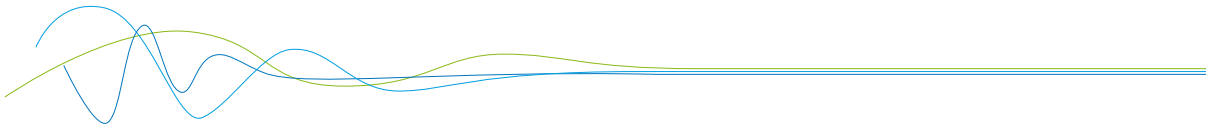

Tab 8: Service

Special functions for deeper diagnostics/settings.

These are read in once after opening the tab.

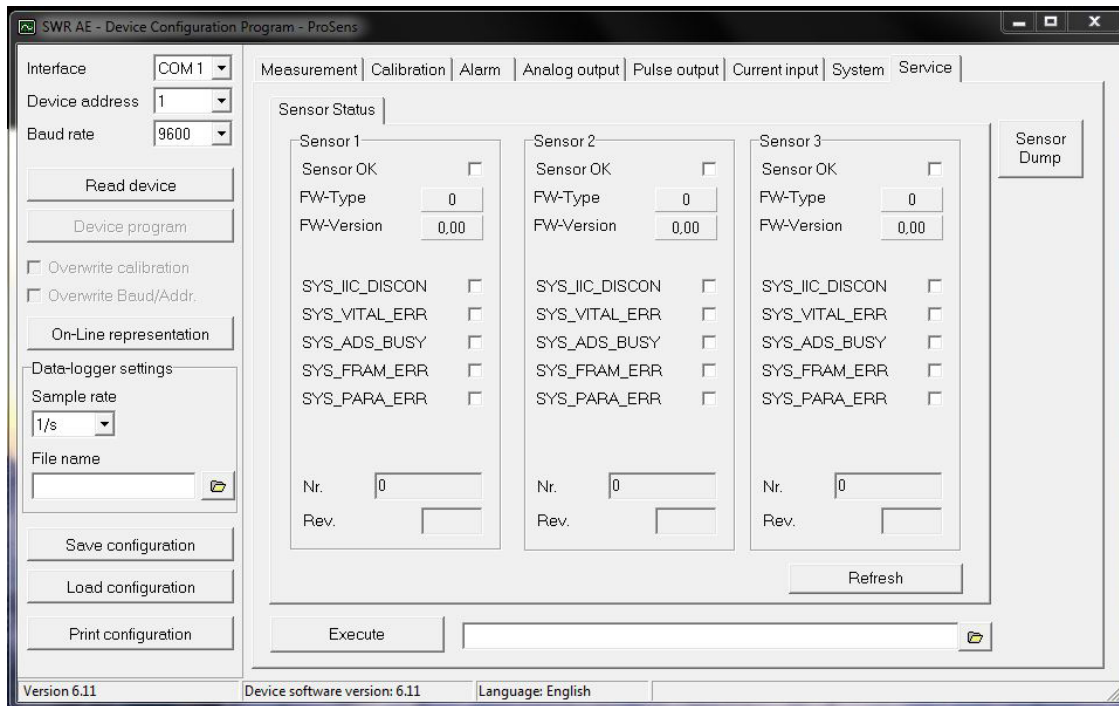

- Sensor status: indicates the status of the connected sensors
 - Error status: Sensor OK
 - Fw type (31 for ProSens, PicoFlow – otherwise sensor ID error)
 - FW version
 - Error messages of the sensor for diagnostics
 - Serial number/Revision
- Contrast: external adjustment option for the sensor contrast value
- Refresh: read in again
- Start (file selection, path display): an external program can be saved and started here.
 - Service functions with deeper access to the sensors
 - Log functions via service software
 - The customer software pauses as long as the external program is executing
- Sensor dump:
 - Save the Modbus register of the connected sensors
 - ENVEA Process own number format, helpful for diagnostic purposes by ENVEA Process
 - Directly in the program directory
 - Default name

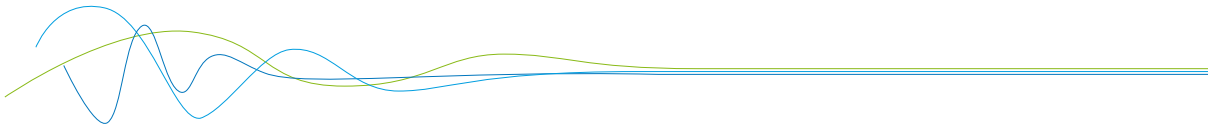

7. Fitting up to 3 sensors

As an option up to 3 sensors can be connected to the Evaluation unit (field housing or DIN Rail) via the C3-Box to allow large pipe cross-sections to be monitored better.

The sensor addresses and the registration of the sensors on the Evaluation unit is completed at the factory and cannot be changed by the user.

The configuration is identical to the configuration of a single system:

The raw value is formed as the arithmetic mean of the raw values of the individual sensors.

The raw values of all the sensors can be viewed in the online display.

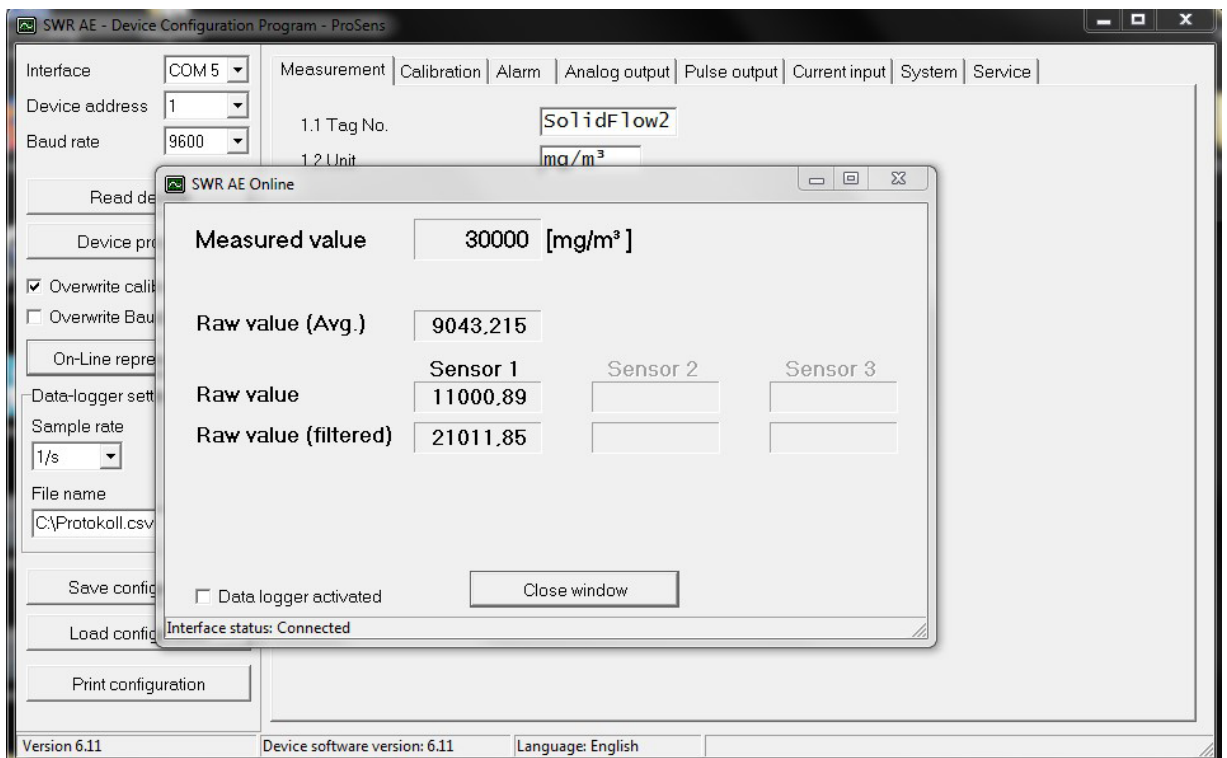

The error monitoring is extended to all registered sensors.

- If one sensor is missing this will cause a sensor error
- The occurrence of an internal error in a sensor will cause a sensor error
- A sensor error will be signalled as follows:
 - Field housing: "Sensor error" will be shown on the display
 - DIN Rail: the RUN LED will flash quickly
 - Both: reduction in current output to the alarm value

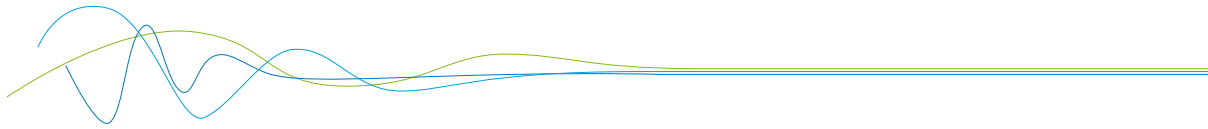

8. Maintenance

Maintenance work is restricted to removing the sensor from the process now and again and cleaning any accumulated particles off the probe and the insulation section using a cloth.

This is designed to prevent accumulated material resulting in bridge formation against the earthed environment since this has a significantly adverse effect on the measurement. The other aim is to prevent the probe becoming encased with accumulated material.

If the particles tend heavily towards accumulation the maintenance work should be carried out more frequently. No maintenance work is required in the sensor housing or on the Evaluation unit.

9. Warranty

On condition that the operating conditions are maintained and no intervention has been made on the device and the components of the system are not damaged or worn, the manufacturer provides a warranty of 1 year from the date of delivery.

In the event of a defect during the warranty period, defective components will be replaced or repaired at ENVEA Process plant free of charge as considered appropriate. Replaced parts will become ENVEA Process property.

If the customer requests that parts be repaired or replaced at his site, the customer must pay the travel expenses for ENVEA Process service personnel.

ENVEA Process cannot accept any liability for damage not suffered by the goods themselves and in particular ENVEA Process cannot accept liability for loss of profit or other financial damages suffered by the customer.

10. Error messages / Sensor status

HEX	HEX	BIN	BIN	DEC	Error	Status ERR PROC	Display indication	DR flashing	Current output
Hi	Low	Hi	Low						
00	01	00000000	00000001	1	unused	ERR	E001	1	4 ... 20 mA
00	02	00000000	00000010	2	SYS_IIC_DISCON	ERR	E002	3	2 mA
00	04	00000000	00000100	4	SYS_VITAL_ERR	ERR	E004	3	2 mA
00	08	00000000	00001000	8	unused	ERR	E008	1	4 ... 20 mA
00	10	00000000	00010000	16	SYS_ADS_BUSY	ERR	E010	3	2 mA
00	20	00000000	00100000	32	unused	ERR	E020	1	4 ... 20 mA
00	40	00000000	01000000	64	unused	ERR	E040	1	4 ... 20 mA
00	80	00000000	10000000	128	SYS_FRAM_ERROR	ERR	E080	3	2 mA
01	00	00000001	00000000	256	SYS_PARA_ERROR	ERR	E100	3	2 mA
02	00	00000010	00000000	512	unused	ERR	E200	1	4 ... 20 mA

- Errors are indicated in hexadecimal addition.
SYS_FRAM_ERROR and SYS_PARA_ERROR simultaneously indicate E180.
SYS_VITAL_ERR and SYS_IIC_DISCON simultaneously indicate E006.

10.1 Response to errors

- SYS_VITAL_ERR describes caking on the sensor and can be rectified by cleaning at the customer.
 - bridging occurring short-term is also detected
 - indicated for at least 1 minute
 - adjustable at the sensor (Service function)
- All other errors are serious hardware faults and cannot be rectified by the customer. The sensor must be returned to the factory.

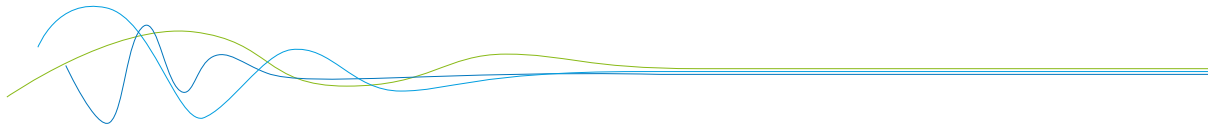

The devices comply with the following standard:

	Product standard - electrical equipment for measurement, testing and laboratory use EMC requirement
	Reference standard EN 661326
	Year of publication (1997) Updates A1 (1998), A2 (2001), A3 (2003)

11. Technical data

Sensor	
Measurement objects	Solid particles in the gas current
Measurement range	From 0.1 mg/m ³
Measuring range setup	Precalibrated
Process temperature	Standard: -20 °C / +150 °C; optional: -20 °C / +500 °C
Ambient temperature	-15 ... +60 °C
Pressure	Max. 2 bar
Air velocity	Min. 2 m/s
Humidity	95 % RH (non-condensing)
Measurement principle	Electrodynamic
Attenuation time	0.1 s ... 99.9 s
Sensor rod	Material: stainless steel; length: 500 / 1000 mm
Housing material	Aluminium
Use in Ex zones	Ex zones of category 1/2 gas + dust
Protection type	IP66
Power supply	24 ± 10 % V DC by Evaluation unit
Rating	1.2 W
Electrical connection	Integrated connection chamber DIN M 20
Relay contact	Max. rated load: 125 V AC, 60 V DC Max. peak current: 2 A Max. rated load: 0.5 A at 125 V AC, 1 A at 24 V DC Max. breaking capacity: 1 A Not in EX devices Cat. 1 and 2
Cable (power + signal)	4-wire
Process connection	R 1" external thread
Weight	Approx. 1.5 kg

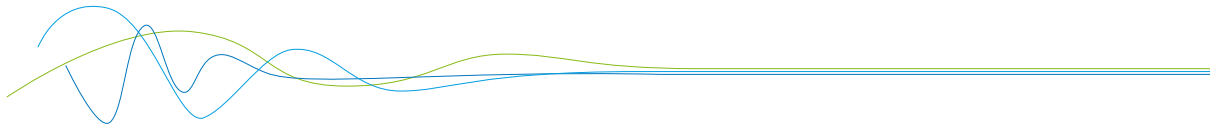

11. Technical Data

Evaluation unit MSE 300-FH	
Power supply	110 / 230 V AC 50 Hz (optional 24 V DC)
Power consumption	20 W / 24 VA
Protection category	IP65 to EN 60 529/10.91
Ambient operating temperature	-10 ... +45 °C
Dimensions	258 x 237 x 174 mm (W x H x D)
Weight	Approx. 2.5 kg
Interface	RS 485 (ModBus RTU) / USB
Cable screw connectors	3 x M20 (4.5 - 13 mm Ø)
Connection terminals cable cross-section	0.2 - 2.5 mm ² [AWG 24-14]
Current output	3 x 4 ... 20 mA (0 ... 20 mA), load < 500 W (Active)
Relay contact	Max. rated load: 250 V AC Max. peak current: 6 A Max. rated load 230 V AC: 250 VA Max. breaking capacity DC1: 3/110/220 V: 3/0.35/0.2 A Min. switching load: 500 mW (10 V/5 mA)
Data backup	Flash memory
Pulse output	Open Collector - Max. 30 V, 20 mA
Evaluation unit MSE 300-DR	
Power supply	24 V DC ± 10 %
Power consumption	20 W / 24 VA
Protection type	IP40 to EN 60 529
Ambient operating temperature	-10 ... +45 °C
Dimensions	23 x 90 x 118 (W x H x D)
Weight	Approx. 172 g
Interface	RS 485 (ModBus RTU) / USB
DIN Rail fastening	DIN 60715 TH35
Connection terminals cable cross-section	0.2 - 2.5 mm ² [AWG 24-14]
Current output	1 x 4 ... 20 mA (0 ... 20 mA), load < 500 W (Active)
Relay contact	Max. rated load: 250 V AC Max. peak current: 6 A Max. rated load 230 V AC: 250 VA Max. breaking capacity DC1: 3/110/220 V: 3/0.35/0.2 A Min. switching load: 500 mW (10 V/5 mA)
Data backup	Flash memory
Pulse output	Open Collector - Max. 30 V, 20 mA

